

---

Report to the State of Michigan

# Alternatives for replacing Enbridge's dual Line 5 pipelines crossing the Straits of Mackinac

---

June 15, 2018



## Table of Contents

---

<b>Executive Summary</b>	<b>1</b>
The Purpose of This Report	1
Summary of Key Conclusions	1
Summary Comparison of the Two Feasible Alternatives	5

---

<b>Reporting Parameters and Process</b>	<b>6</b>
How Enbridge Defines Feasibility in the Context of This Report	6
How Enbridge Prepared This Report	6
Consultants for the Three Alternatives Feasibility Assessments	7

---

<b>Enbridge’s Line 5 in Michigan</b>	<b>8</b>
--------------------------------------	----------

---

<b>Alternative: Tunnel</b>	<b>10</b>
Highlights of the Tunnel Alternative	10
Overview of Underwater Tunnels	11
Tunnel planning and design	11
Tunnel construction	12
Tunnel lining	13
Pipe installation	13
Tunnel access	14
Summary of Feasibility Study for a Line 5 Tunnel under the Straits	16
Tunnel consultants	16
Tunnel feasibility	16
Tunnel configuration options	17
Straits tunnel specifications	18
Geological considerations	19
Tunnel depth	20
Tunnel diameter and lining	21
Placing other utilities in the tunnel	22
TBM type	22
Approximate construction sequence	23
TBM launch and reception	23
Spoil handling and disposal	24
Pipeline installation	24
Independent Assessment of Hatch’s Tunnel Feasibility Study	25
Construction Cost Estimate	25
Project Execution Schedule	25
Tunnel Permits and Approvals	25
Tunnel Risk Assessment	26
Geologic hazards	26

---

<b>Alternative: Open Cut With Secondary Containment</b>	<b>28</b>
Highlights of the ‘Open Cut with Secondary Containment’ Alternative	28
Overview of the Open Cut Construction Method	29
Summary of Feasibility Study for Installing a Pipeline across the Straits using the Open Cut Construction Method with a Pipe-in-Pipe Secondary Containment System	30
Open cut consultants	30
Open cut feasibility and design options	30
Open cut construction method	31
Why is trenching the entire length of lakebed not the preferred option?	31
Pipeline installation	31
Onshore work spaces	33
Pipeline route options	33
Secondary containment: pipe-in-pipe system	35
Mechanical design considerations	35
Anchor drop and drag protection	37
Anchor size considerations	39
Placing the engineered protective cover on the pipeline	40
Corrosion protection	41
Shore approaches and burial design	42
Onshore worksites	43
Geological considerations	43
Independent Assessment of INTECSEA’s ‘Open Cut with Secondary Containment’ Feasibility Study	44
Construction Cost Estimate	44
Construction Schedule	44
Open Cut Permits and Approvals	44
Open Cut with Secondary Containment Risk Assessment	45

---

<b>Alternative: Horizontal Directional Drilling</b>	<b>46</b>
Overview of the HDD Construction Method	46
Summary of Results of the HDD Feasibility Study	48
HDD consultants	48
Objectives of the HDD feasibility study	48
HDD options and concerns	49
Independent Assessment of JDH&A’s HDD Feasibility Study	49
Conclusion Regarding the Feasibility of the HDD Alternative	49

---

<b>Environmental Impacts of the Two Feasible Alternatives</b>	<b>50</b>
Potential Environmental Impacts—Applicable to Both the Tunnel and Open Cut Alternatives	51
Potential Environmental Impacts—Specific to the Tunnel Alternative	56
Potential Environmental Impacts—Specific to the Open Cut with Secondary Containment Alternative	57

---

<b>Reliability Assessment of the Two Feasible Alternatives</b>	<b>59</b>
Probability of a Product Release into the Straits	62
Key Findings	62

---

<b>Enbridge’s Conclusions</b>	<b>63</b>
Summary Comparison of Critical Factors	63

---

<b>Appendices</b>	<b>65</b>
Appendix 1: Tunnel Plan and Profile Drawings	67
Appendix 2: Accessible Tunnel—Advantages and Disadvantages	69
Appendix 3: Backfilled Tunnel—Advantages and Disadvantages	69
Appendix 4: High-Level Schedules for Each Feasible Alternative	70
Appendix 5: Permits and Approvals Required for the Tunnel and Open Cut with Secondary Containment	71
Appendix 6: Environmental Areas of Interest	74
Appendix 7: Reliability Assessment	75
Appendix 8: Consultants’ Profiles	89
Appendix 9: Glossary	92
Abbreviations and acronyms	92
Definitions	93



# Executive Summary

## The Purpose of This Report

On November 27, 2017, the State of Michigan and Enbridge signed a wide-ranging agreement setting out a plan to improve coordination between Enbridge and the State for the operation and maintenance of the Line 5 pipeline located in Michigan, while also providing enhanced transparency to the citizens of Michigan.

In Section F of that agreement, Enbridge committed to assessing the feasibility of three alternatives to replace the dual, 20-inch Line 5 pipelines across the Straits of Mackinac (the Straits) with a new pipeline that is either:

- i. placed in an underground tunnel below the Straits;
- ii. installed across the Straits using an open-cut method that includes secondary containment\*<sup>1</sup>; or
- iii. installed below the Straits using the horizontal directional drilling (HDD) method.

Enbridge also committed to report on its findings by June 15, 2018, and include in its report:

- iv. the costs and engineering considerations associated with each alternative;
- v. the potential environmental impacts that may result from the construction, operation and maintenance of the alternatives; and
- vi. the approvals or authorizations that would be necessary to construct, operate and/or maintain each alternative.

This report summarizes the findings of Enbridge's feasibility assessment of the three alternatives, as well as the associated costs, engineering considerations, potential environmental impacts and mitigation measures, and permits and approvals.

---

## Summary of Key Conclusions

Enbridge engaged three Lead Engineering Consultants—prominent engineering companies that specialize in tunneling, offshore pipelines and horizontal directional drilling—to assess and report on the technical feasibility of each alternative. Then, three separate teams of independent expert Engineering Consultants and three separate teams of expert Constructibility Reviewers assessed and verified the Lead Engineering Consultants' conclusions regarding feasibility and construction approach.

Simultaneous to the three feasibility studies, Enbridge engaged two respected Environmental Consulting firms—one as the Lead Consultant and another as an Independent Reviewer—to assess and verify the potential environmental impacts and mitigation measures related to each alternative. Enbridge also evaluated the U.S. regulatory and environmental permits and approvals that would be required.

\* A secondary containment system provides another line of defense in the unlikely event of a failure of the primary product pipeline. The system provides containment of discharged product until the appropriate actions are taken to abate the source of the discharge and remove oil from areas where it has accumulated to prevent it from reaching navigable waters or adjoining shorelines.

Out of that process, Enbridge has concluded that the technical feasibility of the three alternatives is as follows:

Alternative	Technical Feasibility
Tunnel	Feasible
Open cut with secondary containment	Feasible
Horizontal directional drilling	Not feasible

**Tunnel highlights** (Figure 1)

- Enbridge has concluded that tunnel construction under the Straits of Mackinac is feasible and, with proper maintenance and inspection, provides a safe, robust, long-term facility.
- The proposed tunnel would be excavated with a Tunnel Boring Machine (TBM).
- The maximum tunnel depth would be approximately 350 feet below the lake surface and approximately 100 feet beneath the lakebed at its deepest point.
- The completed tunnel would contain one 30-inch hydrocarbon pipeline.
- The proposed tunnel would have a 12-foot outside diameter and a 10-foot inside diameter and would be just over four miles in length, which is well within the size and length range of tunnels constructed around the world.
- Many tunnels have been completed under lakes, rivers and seas; numerous energy pipeline tunnels have been constructed to date, particularly in the last five to 10 years.
- Should this alternative move forward, detailed geotechnical investigations would be carried out to optimize tunnel design and engineering.
- The tunnel would be a portal-to-portal design, meaning tunnel construction would begin from a launch portal located near Enbridge’s existing North Straits Station and finish at a reception portal located near Enbridge’s Mackinaw Station on the south shore. The exact location of the two portals would be determined during the next phase of design.
- In the unlikely event of a hydrocarbon release from the pipeline, the concrete tunnel would act as a secondary containment system, with two secondary-containment features:
  - The tunnel interior would be lined with precast reinforced concrete lining that incorporates high-strength gaskets.
  - The annulus (the space outside the concrete lining) would be filled with cement grout.
- A reliability assessment of the tunnel alternative demonstrated there is no credible scenario that would result in a release of product from the tunnel into the Straits. The probability of this occurring is estimated to be negligible, which means the probability is considered to be virtually zero.

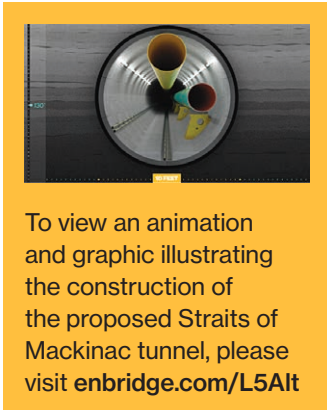
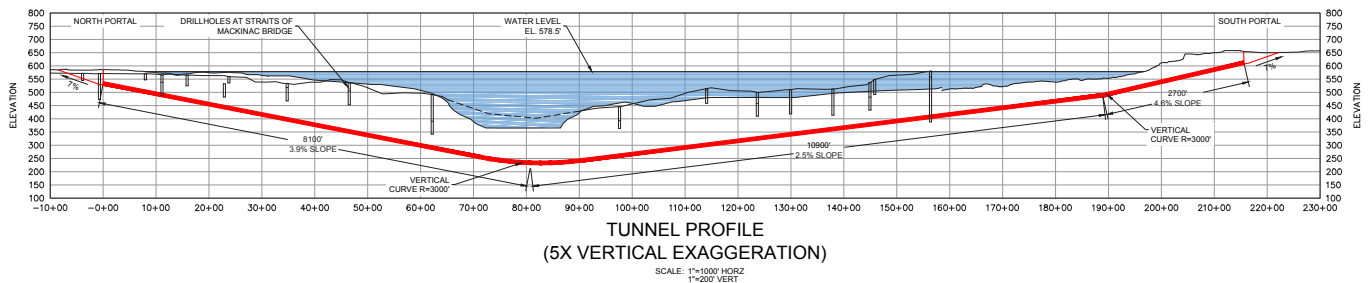



Figure 1: Profile drawing of a Line 5 Straits tunnel (illustrated with a 5x vertical exaggeration to aid visualization).



- The tunnel would avoid construction impacts to shorelines and the lakebed. It would require 10 to 15 acres of temporary workspace on the north shore entry location and two to eight acres at the south shore exit location.
- Disturbed onshore areas would be reclaimed once construction is completed. The permanent operational footprint would likely be a fenced enclosure of up to one acre for the entry and exit locations.
- The tunnel would require at least 15 state and federal permits. The primary regulators would be the U.S. Army Corps of Engineers, Michigan Department of Environmental Quality, Michigan Department of Natural Resources and Michigan Public Service Commission.
- Several local permits—zoning, building, special use, etc.—would be required from two cities, one county and one township.

**Open cut highlights** (Figures 2 and 3)

- Enbridge has concluded that a pipeline using the open cut construction method and featuring secondary containment can be safely installed across the Straits.
- The pipeline would be a pipe-in-pipe system consisting of a 30-inch inner pipe that would carry the hydrocarbon products, and a 36-inch outer pipe that would provide secondary containment.
- The 36-inch outer pipe would include a leak detection system, enabling continuous real-time monitoring of the pipe-in-pipe annulus (the space between the inner and outer pipe) so that any leak from the 30-inch pipe can be identified and immediate action can be taken, including system shut-down.



**Pipe-In-Pipe**

TRANSPORTATION PIPE 30"  
CONTAINMENT PIPE 36"  
SYNTHETIC SPACERS

To view an animation and graphic illustrating construction of a pipeline across the Straits of Mackinac using the open cut construction method and featuring pipe-in-pipe secondary containment, please visit [enbridge.com/L5Alt](http://enbridge.com/L5Alt)

Figure 2: Proposed pipe-in-pipe system configuration.

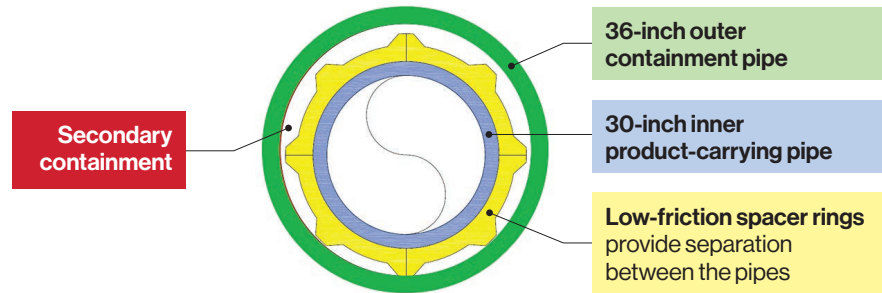
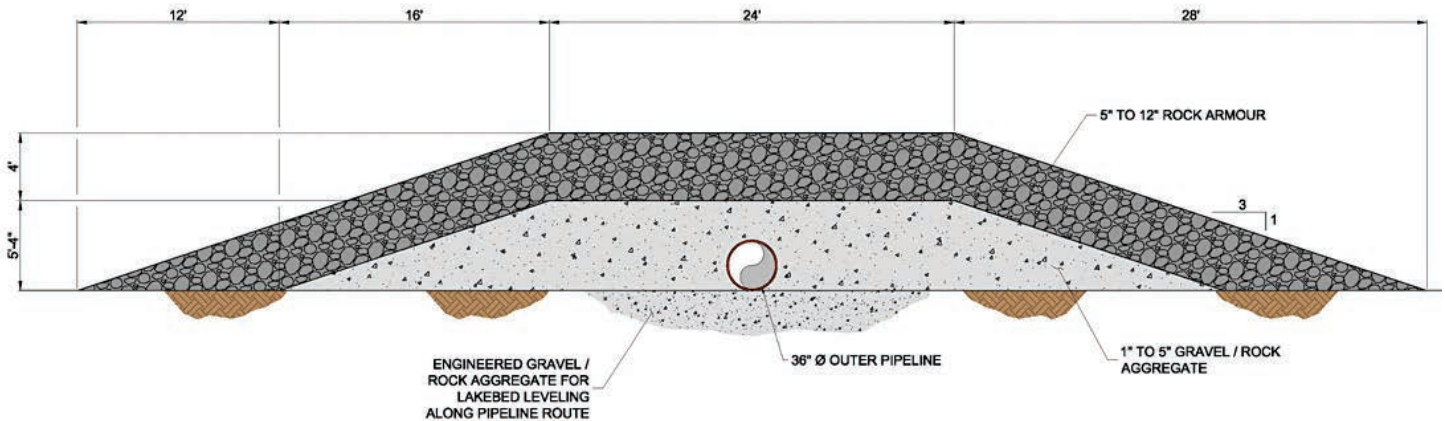

Figure 3: Pipeline covered with engineered protective cover across the lakebed.



- The pipeline would be trenched to 30 feet of water depth (approximately one-half mile offshore) and then laid on the lakebed.
- To protect the pipe-in-pipe system against damage from anchor strikes or other dropped objects, the system would be covered with engineered protective cover made of gravel and cobble, which is rock ranging in size from approximately one to 12 inches. From the top of the pipe, the engineered protective cover would be six- to eight-feet thick.
- Should this alternative move forward, lakebed geotechnical data would be gathered to optimize design and engineering of the open cut route and the height of the engineered protective cover.
- A reliability assessment of the open cut alternative demonstrated the probability of a release into the Straits is reduced significantly by the secondary containment feature of the outer pipe. The release probability is estimated to be  $2.43 \times 10^{-7}$ .
- The open cut method would have an impact on the shorelines and lakebed and would permanently alter the lakebed surface resulting from the placement of the engineered protective cobble cover over the pipeline.
- Onshore workspaces six to eight acres in size on the north shore and one to two acres on the south shore would be required. Disturbed onshore areas would be reclaimed once construction is completed. There are no new significant above-ground permanent facilities anticipated.
- The open cut method would require at least 15 state and federal permits. The primary regulators would be the U.S. Army Corps of Engineers, Michigan Department of Environmental Quality, Michigan Department of Natural Resources and Michigan Public Service Commission. The scope of the open cut method likely would be considered by regulators to have the potential for impacts that may not fit the definition of minimal individual and cumulative adverse environmental effects. This means an Individual Permit likely would be required and that could prolong the permitting process.
- Several local permits—zoning, building, special use, etc.—would be required from two cities, one county and one township.

#### **Horizontal directional drilling**

- Several HDD options were considered but all were determined to be not technically feasible, so the HDD alternative was withdrawn from consideration. Reasons included: the 30-inch diameter of the pipe required; the hard characteristics of the subsurface rock (dolomite and limestone); and the length of the drill required, which would be more than double any comparable crossing that has been completed to date.

## Summary Comparison of the Two Feasible Alternatives

	Tunnel	Open cut with secondary containment
Enbridge's opinion	Feasible	Feasible
Lead Engineering Consultant's opinion	Feasible	Feasible
Independent Consultant's opinion	Feasible	Feasible
Constructibility Reviewer's opinion	Constructible	Constructible
Estimated cost	\$350 – 500 million	\$250 – 300 million
Project timeline (including planning, design, permitting and construction)	5 to 6 years	4 to 5* years * Schedule would be sensitive to seasonality.
Pipeline location	A 30-inch pipeline located within a concrete-lined tunnel and mounted on pipe supports within the tunnel. The tunnel would be located approximately 350 feet below the lake surface and approximately 100 feet beneath the lakebed at its deepest point.	Trenched to 30 feet of water depth (approximately one-half mile offshore); remaining length laid on the lakebed and covered in engineered protective cover. From the top of the pipe, the protective cover would be six- to eight-foot thick.
Secondary containment feature	Tunnel would be lined with precast concrete tunnel lining that incorporates high-strength gaskets. The annulus outside the lining would be filled with cement grout.	Pipe-in-pipe system with the 30-inch product pipe contained within a 36-inch outer secondary containment pipe.
Risk of product release into the Straits	Negligible—considered virtually zero.	The secondary containment design of the pipe-in-pipe system combined with the engineered protective cover reduces the probability of a release into the Straits to an extremely low value.
Potential environmental impacts	<p><b>Construction:</b> No impact to shorelines and lakebed; onshore work space would be 10 to 15 acres on the north shore and two to eight on the south shore. Marine work just for geotechnical investigation program— one summer season.</p> <p><b>Operations:</b> Disturbed onshore areas would be reclaimed after construction; new operational footprint of up to a one-acre fenced-in area with an above-ground structure over the portal entrances on each shore.</p>	<p><b>Construction:</b> Impact to shorelines likely to be considered minimal; impact to lakebed may not fit the regulators definition of having minimal effects— likely would require an Individual Permit. Onshore workspaces six to eight acres in size on the north shore and one to two acres on the south shore would be required. Marine work for two consecutive summer seasons; plus one summer season for geotechnical investigation/surveys.</p> <p><b>Operations:</b> Disturbed onshore areas would be reclaimed after construction; no new significant above-ground permanent facilities anticipated.</p>
Incident prevention	24/7/365 monitoring and regular inspections.	24/7/365 monitoring and regular inspections of both the internal product pipe and the engineered protective cover.
Pipeline accessibility and maintenance	Tunnel would be open and accessible, and the pipeline would be supported within the tunnel, providing sufficient space for pipeline inspection and maintenance.	If the pipeline needs to be accessed at any location, the engineered protective cover can be removed by subsea construction equipment and divers. If repairs are required, they would be challenging due to depth of water and the pipe-in-pipe system.

# Reporting Parameters and Process

## How Enbridge Defines Feasibility in the Context of This Report

This feasibility report focuses on the technical feasibility of the three alternatives summarized above.

A project is technically feasible if it can be carried out using existing equipment, technology and techniques, regardless of uncertainties around installation cost.

The economic viability, environmental compatibility and the potential for public acceptance of the chosen alternative would be subject to further discussion and review.

Also, should one of the two feasible alternatives move forward, it would be subject to considerably more detailed design and engineering than is presented in this feasibility study.

During the feasibility assessment process, Enbridge identified the most significant risks for the three alternatives to determine if there were any feasibility 'show-stoppers'. A more detailed risk register would also be developed should one of the alternatives advance to the next phase of development.

---

## How Enbridge Prepared This Report

Enbridge used a robust process for assessing the feasibility of each alternative.

The feasibility of each alternative went through multiple levels of expert review:

1. We engaged a Lead Engineering Consultant to produce a report assessing the feasibility of the alternative and to serve as the primary point of contact for the study.
2. We engaged an Independent Consultant, who (a) was given all the work and background information that was produced by the Lead Engineering Consultant and (b) provided an assessment of the Lead Engineering Consultant's conclusions.
3. We provided the Lead Engineering Consultant's work to a Constructibility Reviewer to provide an assessment of the constructibility of the alternative.
4. We engaged a Lead Environmental Consultant to thoroughly consider the potential environmental impacts of each alternative.
5. We engaged an Independent Environmental Impact Consultant to provide an assessment of the Lead Environmental Consultant's conclusions.
6. We engaged a Reliability Consultant to assess the probability of a product release into the Straits for the two feasible alternatives—tunnel; and open cut with a pipe-in-pipe secondary containment system and engineered protective cover.

All Lead Engineering Consultants, Independent Consultants, Constructibility Reviewers, Environmental Consultants and the Reliability Consultant are renowned for their expertise and are recognized leaders in their respective fields.



The State of Michigan also engaged two subject-matter experts—Daniel Cooper; President & Principal Engineer, HT Engineering, Inc., and Michael A. Mooney, Professor and Grewcock Chair in Underground Construction & Tunneling, Colorado School of Mines—who reviewed and verified the data and participated fully in all aspects of the feasibility study. Both experts have years of experience in pipelines and underground construction.

Dr. Stanley J. Vitton P.E., Associate Professor, Civil and Environmental Engineering, and Affiliated Professor, Geological and Mining Engineering and Sciences at Michigan Technological University was also engaged to provide technical expertise. Dr. Vitton joined the team of experts to assist in the collection and analysis of existing geological and geotechnical information for the project site. He helped the team combine the results of onshore geotechnical investigations with publicly available information.

At various stages of the feasibility assessment process, we organized in-person meetings with all the consultants and experts, including the two State of Michigan topic experts, to review and discuss the work of the Lead Engineering Consultants. Early in the process, a site visit to the Straits was incorporated into a progress-review meeting. One of the meetings regarding the tunnel alternative included a site visit to the 4.3-mile-long Blacklick Creek Sanitary Interceptor Sewer Tunnel that is under construction in Columbus, Ohio and is using similar tunneling techniques to those proposed in this report for a Straits tunnel.

All three Lead Engineering Consultants and the Lead Environmental Consultant circulated their preliminary findings for review by all parties before issuing their detailed final findings.

In this report, we present a summary of the consultants' findings. This report has been reviewed by the respective experts to confirm accurate representation of their findings and opinions.

For each of the three alternatives investigated, there was consensus among the respective experts about the technical feasibility of the three options discussed within this report.

### Consultants for the Three Alternatives Feasibility Assessments

	Tunnel	Open cut with secondary containment	Horizontal directional drilling
<b>Lead Engineering Consultants</b>	Hatch	INTECSEA, Inc.	J. D. Hair & Associates, Inc.
<b>Independent Consultants</b>	Aldea Services LLC	Project Consulting Services, Inc.	GeoEngineers/ADIT Engineering
<b>Constructibility Reviewers</b>	Michels Corporation	Michael Baker International/ Kokosing Industrial's Durocher Marine Division	Michels Corporation
<b>Environmental Impact for All Three Alternatives</b>			
<b>Lead Environmental Consultant</b>	Stantec		
<b>Independent Environmental Impact Consultant</b>	AECOM		
<b>Reliability Assessment for the Two Feasible Alternatives</b>			
<b>C-FER Technologies</b>			

Please see *Appendix 8* for profiles on each of the consulting companies named above.



# Enbridge's Line 5 in Michigan

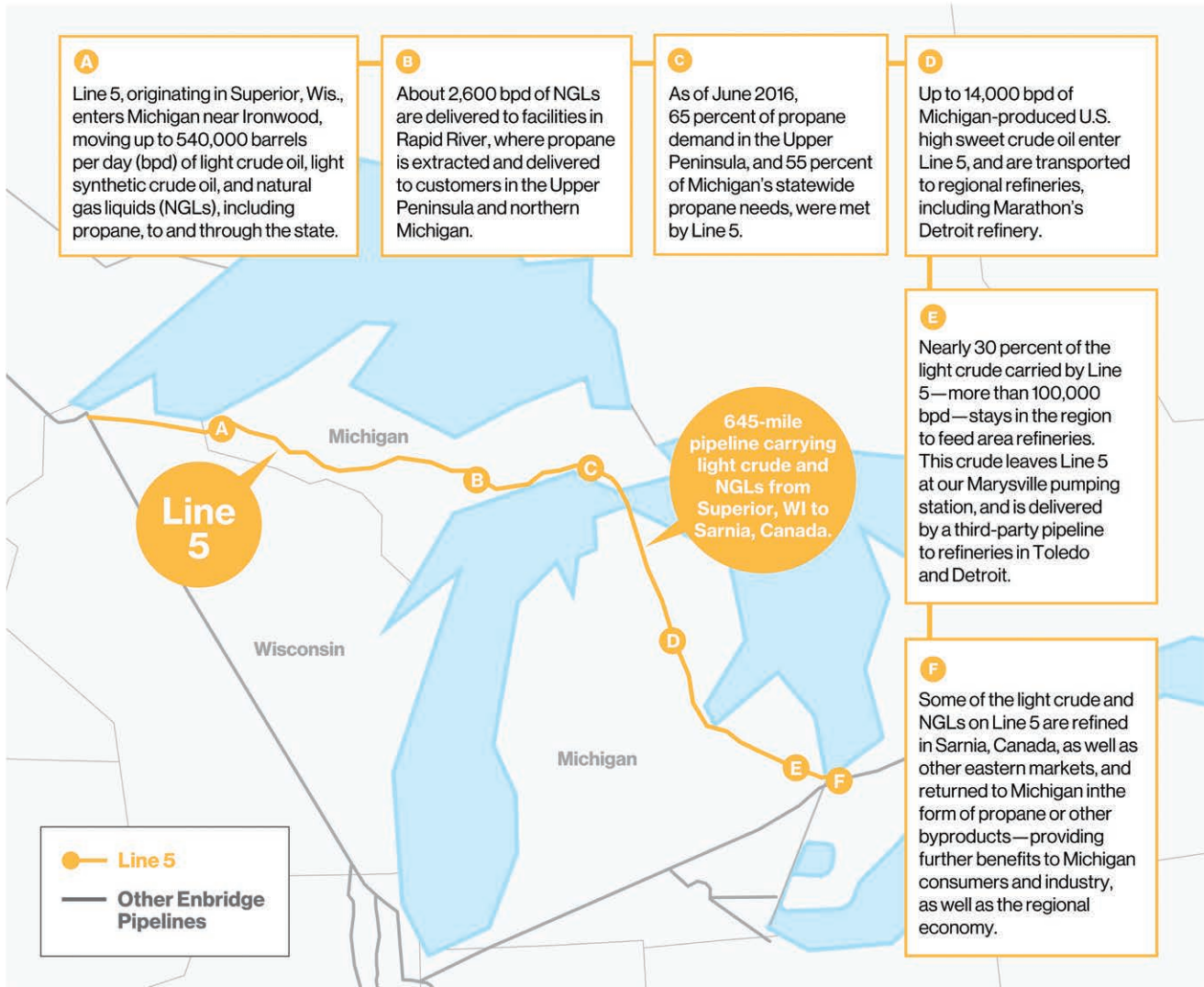

## Quick facts on Line 5

- Enbridge's Line 5 and Line 78 are critical conduits for refineries in the region, supplying the PBF Energy (Toledo), BP (Toledo) and Marathon (Detroit) refineries with crude oil. This essential feedstock is turned into gas, diesel, jet fuel, and other refined products
- Line 5 helps to ensure a stable, secure supply of North American light crude, keeping prices down at the pump
- To date, Line 5 has carried about 80 million barrels of Michigan based light crude to market
- Line 5 does not carry, and has never carried, heavy crude

For more information on today's Line 5, please see the Enbridge brochure *The Straits of Mackinac crossing and Line 5* ([https://www.enbridge.com/-/media/Enb/Documents/Brochures/Brochure\\_Line5.pdf](https://www.enbridge.com/-/media/Enb/Documents/Brochures/Brochure_Line5.pdf)) available at [enbridge.com](http://enbridge.com)



Below, Enbridge's existing dual Line 5 pipelines across the Straits of Mackinac are shown in red. The Mackinac Bridge is the white line on the right.

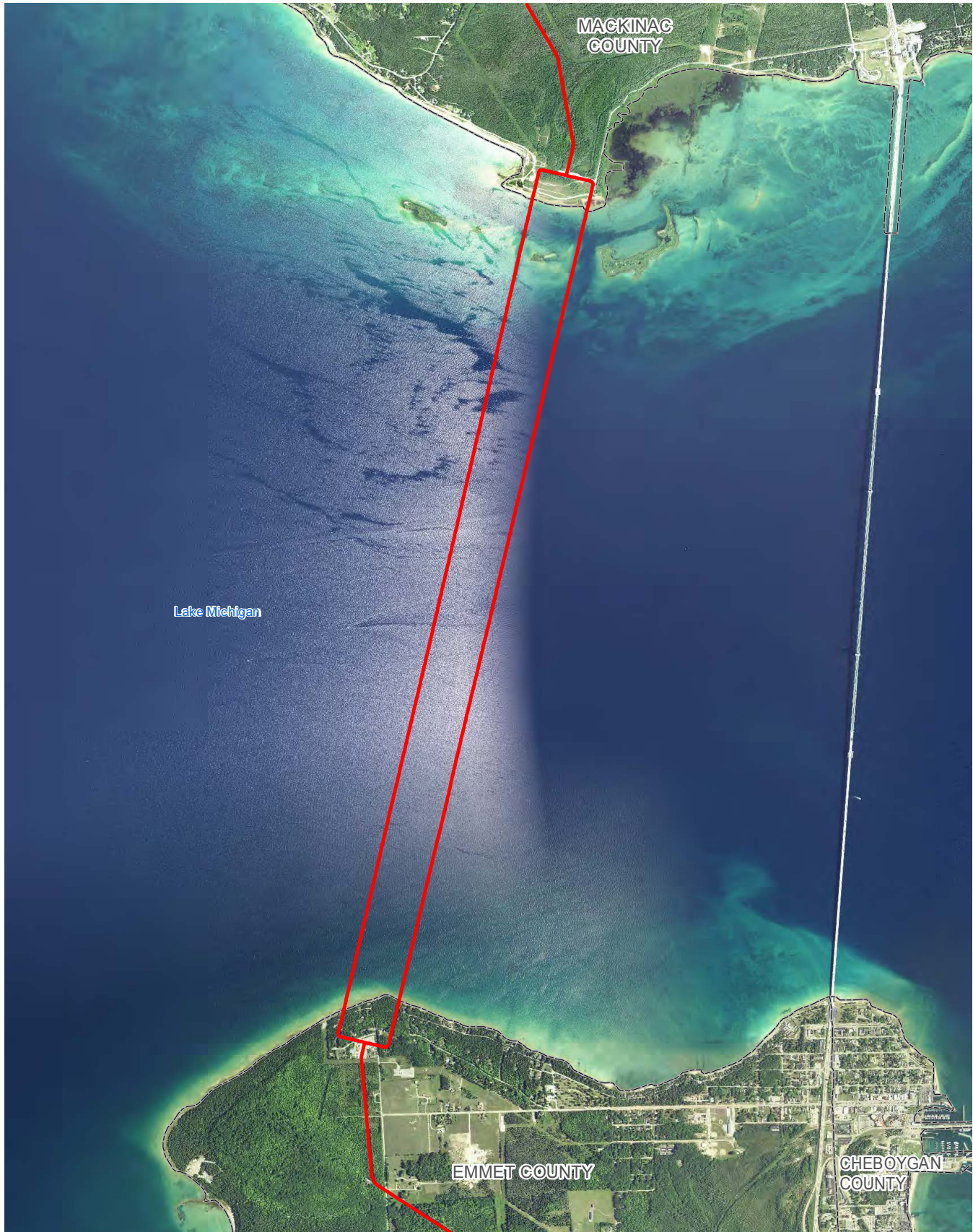

# Alternative: Tunnel

Feasible

Enbridge has concluded that tunnel construction under the Straits of Mackinac is feasible, and with proper design, construction, maintenance and inspection, the tunnel would provide a safe, robust and long-term facility for the Line 5 pipeline. Hatch, the Lead Engineering Consultant for this alternative, states that the proposed 12-foot bored diameter and approximate four-mile length of the tunnel is well within the size range of tunnels constructed elsewhere in the world.

- **Estimated cost:** \$350 – 500 million
- **Estimated timeline:** 5 to 6 years



To view an animation and graphic illustrating the construction of the proposed Straits of Mackinac tunnel, please visit [enbridge.com/L5Alt](http://enbridge.com/L5Alt)

## Highlights of the Tunnel Alternative

	Tunnel
Enbridge’s opinion	Feasible
Lead Engineering Consultant’s opinion	Feasible
Independent Consultant’s opinion	Feasible
Constructibility Reviewer’s opinion	Constructible
Estimated cost	\$350 – 500 million
Project timeline (including planning, design, permitting and construction)	5 to 6 years
Pipeline location	A 30-inch pipeline located within a concrete-lined tunnel and mounted on pipe supports within the tunnel. The tunnel would be located at a maximum depth of approximately 350 feet below the lake surface and approximately 100 feet beneath the lakebed at its deepest point.
Secondary containment feature	Tunnel would be lined with precast concrete tunnel lining that incorporates high-strength gaskets. The annulus outside the lining would be filled with cement grout.
Risk of product leak from pipeline reaching Straits water	Negligible—considered virtually zero. The tunnel itself is a secondary containment feature.
Tunnel design	The tunnel would be a portal-to-portal design, with tunnel construction beginning from a launch portal located near Enbridge’s existing North Straits Station on the north shore and finishing at a reception portal located near Enbridge’s Mackinaw Station on the south shore.
Potential environmental impacts and mitigation measures	<b>Construction:</b> No impact to shorelines and lakebed; onshore work space would be 10 to 15 acres on the north shore and two to eight acres on the south shore. <b>Operations:</b> Disturbed onshore areas would be reclaimed after construction. The permanent operational footprint likely would be a fenced enclosure of up to one acre for the entry and exit locations. The fenced enclosures may contain a graveled area with an above-ground portal structure over the portal entrance that would be approximately 10 feet in height.
Incident prevention	24/7/365 monitoring and regular inspections.
Pipeline accessibility	Tunnel would be open and accessible, and the pipeline would be supported within the tunnel, providing sufficient space for pipeline inspection and maintenance.

## Overview of Underwater Tunnels

Underwater tunnels have a long history. The first one was built between 1825 and 1843 under the Thames River in London, England. Closer to the Straits of Mackinac, both the Michigan Central Railway Tunnel, which opened in 1910, and the Detroit–Windsor Highway Tunnel, which opened in 1930, were constructed beneath the Detroit River and are still in use today.

More recently, many tunnels have been completed under lakes, rivers and seas, including the:

- CN Rail tunnel under the St. Clair River between Michigan and Ontario.
- Oak Creek Power Plant intake tunnel under Lake Michigan in Wisconsin.\*
- San Francisco Bay Pipeline Tunnel in California.\*\*
- NW Interceptor Sewer Tunnel in Sacramento, California.
- Lake Mead Water Intake Tunnel in Nevada.
- Port Mann Watermain Tunnel under the Fraser River in Vancouver, British Columbia.\*
- Numerous undersea road tunnels around the world, such as the Channel Tunnel between the UK and France and the Eurasia Road Tunnel under the Bosphorus Strait in Istanbul, Turkey.

\* Hatch, the Lead Engineering Consultant for this tunnel feasibility study, was involved in this project.

\*\* Michels, the Constructibility Reviewer for this tunnel feasibility study, was involved in this project.

### Tunnel planning and design

Tunnel construction is a complex process that requires significant planning and design. It is essential that geological analysis and risk assessment is carried out early in project planning to decrease the likelihood of unexpected delays during tunnel excavation. Some of the most critical factors are described in the table below.

*Key Factors that Influence Current Pipeline Tunnel Construction Practice*

Key Factor	Current Pipeline Tunnel Construction Practice
<b>Ground conditions—soil and rock types</b>	Bedrock (soft sedimentary to hard granite); soft ground (soil); and mixed ground conditions.
<b>Tunnel length</b>	Can be short distances (<1 mile), or some pipeline tunnels have been as long as ~12 miles.
<b>Tunnel diameter</b>	10-foot to 25-foot diameter tunnels are common.
<b>Ground cover</b>	Up to 2,000 feet deep.
<b>Excavation method</b>	Tunnel Boring Machine (TBM), roadheader/conventional excavation, or drill and blast.
<b>Pipe arrangement</b>	Single and multiple pipes of various sizes and configurations.
<b>Backfilled/Open</b>	Full backfill; partial backfill; or open and accessible (see details below).
<b>Tunnel structure</b>	Precast concrete lining is the most common type of lining used in tunnels (see details below).
<b>Fire and life safety in open tunnel</b>	Full fire- and life-safety equipment; or rely on equipment brought into the tunnel.

To complete the design of the tunnel, engineers have to analyze these and other factors. This information is also required to secure permits and approvals from regulatory and environmental agencies. Once the design and excavation plans are complete and all necessary approvals received, construction can begin.



## Tunnel construction

Tunnel builders typically use two methods to excavate rock:

1. **Drill and blast:** This is a common excavation method for short tunnels in medium- to hard-rock conditions. It involves the use of explosives. Drill and blast is not appropriate for the Straits because of its length, uncertain ground conditions, and risks of water inflows.
2. **Tunnel Boring Machines** (Figure 4): TBMs are technically sophisticated pieces of equipment used to excavate tunnels in all types of ground conditions. TBMs can be configured so that they are suited to conditions with high groundwater pressure.

Excavation by TBM is the method being considered for a Line 5 tunnel.

TBMs are made of three sections—rotating cutterhead; shield (in the case of shielded TBMs); and trailing gear—and are typically about 300 feet long. Disc cutters on the cutterhead break small rock chips from the tunnel face by rotating and applying high contact pressure. The shield skin provides for the safety of personnel and the TBM. The trailing gear contains the TBM's electrical, mechanical, guidance systems and additional support equipment. Hydraulic cylinders located in the trailing gear propel the TBM forward a few feet at a time.

As the cutterhead slowly rotates, the rock chips fall onto a conveyor system and are carried to the rear of the machine where it is placed into haulage units and removed from the tunnel. The excavated material is moved off site and disposed of in a manner consistent with applicable environmental regulations.

TBMs are often launched from a portal, which is an open trench extending through the overburden (the soil and subsoil above the bedrock) into the bedrock.

### What is groundwater?

Groundwater is the water found underground in the cracks and spaces in soil, sand and rock.

For a Straits tunnel, Enbridge recommends the use of one TBM launched from a portal on the north shore.

Figure 4: A large TBM—with a 36-foot-diameter cutterhead and shield (foreground) and trailing gear (background) for a total length of almost 400 feet and weight of over 2,200 tons—is readied for the start of construction of the Filder Rail Tunnel in Germany. (Source: Herrenknecht)



For a Straits tunnel, Enbridge recommends the use of a PCTL lining.

### Tunnel lining

Tunnels are commonly lined with precast concrete tunnel lining (PCTL) (Figure 5). PCTL is installed in segments from the tail section of the TBM shield as the boring progresses, enabling continuous tunneling and safe working conditions. PCTL incorporates high-strength gaskets.

Figure 5: Precast concrete lining in the completed Eurasia Tunnel project in Istanbul. (Source: Herrenknecht)



For a Straits tunnel project, Enbridge recommends welding the pipe outside the tunnel.

### Pipe installation

Once the tunnel is constructed, there are several options for installing the pipe. One is to weld the pipe outside the tunnel and then push it through the tunnel using a pipe thruster (Figure 6). Another option is to transport the pipe into the tunnel in longer segments to limit the number of welds inside the tunnel.

Figure 6: A pipe thruster pushing pipe.





## Tunnel access

As noted above in *Tunnel planning and design*, completed pipeline tunnels can be filled with cementitious backfill and not accessible; partially backfilled; or open and 100 percent accessible (no backfill). *Figure 7* below illustrates these three options.

*Figure 7: Three common configurations of completed tunnels.*

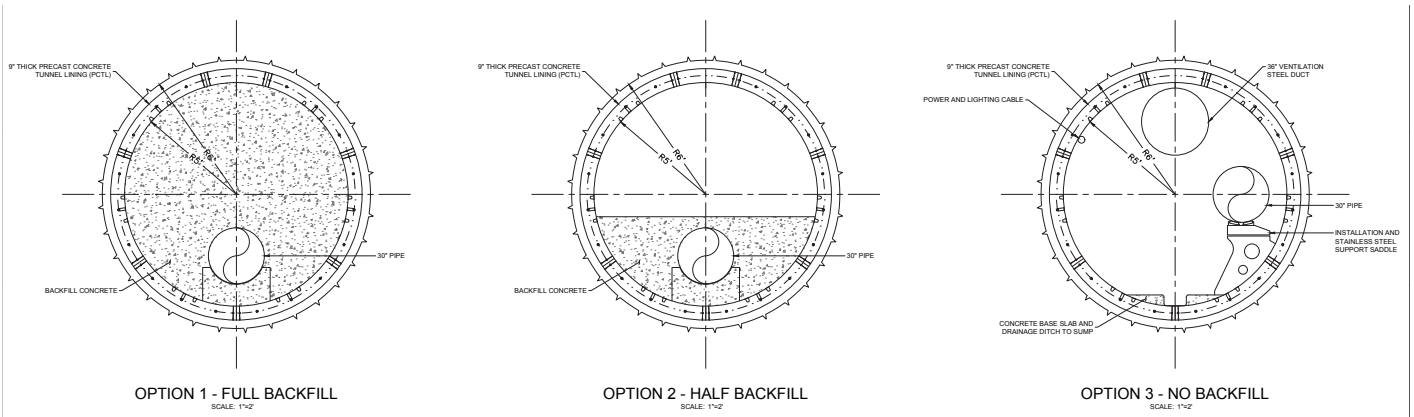

Enbridge recommends that a Straits tunnel should be open and accessible.

In an open and accessible tunnel, the pipeline is mounted on pipe supports (*Figure 8*). An open tunnel allows for pipeline maintenance, future pipeline installation, and inclusion of other third-party services/assets. The condition of open tunnels needs to be assessed periodically during pipeline operation, so space is provided for inspection and maintenance by access vehicles (*Figure 9*), mechanical and electrical equipment, and ventilation equipment.

For fully backfilled tunnels (*Figure 10*) and partially backfilled tunnels, the tunnel is backfilled with a cement-type material. The backfill material is designed to prevent damage to the pipe, and to provide both final support to the pipe and to cut off water seepage into the tunnel.

*Figure 8: The GASTAU Tunnel (below), which runs below a state park in Brazil, is a 3.2-mile open and accessible tunnel with a 28-inch diameter high-pressure gas pipeline leading to a refinery. The tunnel was excavated using a TBM and a pre-cast concrete lining.*

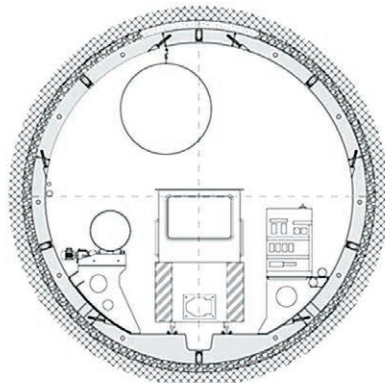
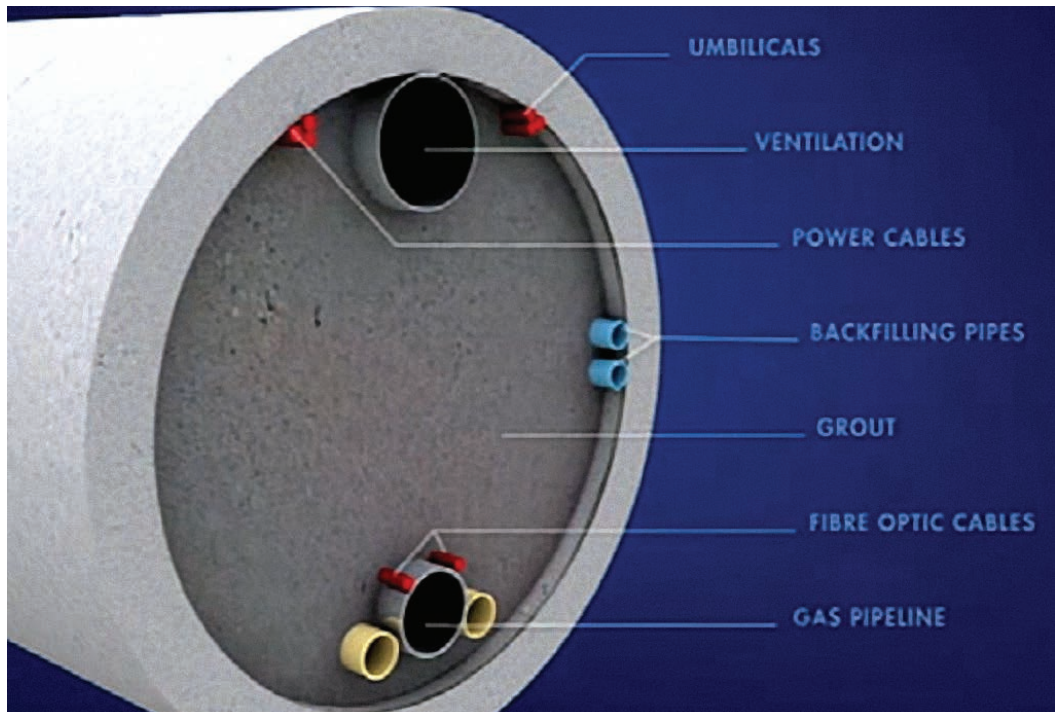



Figure 9: The tunnel access vehicle pictured at left serves the Felbertauern Oil Pipeline Tunnel in Austria. (Source: TransAlpine Tunnel)



Figure 10: The Corrib Gas Pipeline Tunnel, which is operated by Shell Ireland, is fully backfilled. (Ref: Shell Ireland project website)



Please see *Appendix 2* and *Appendix 3* for a summary of the advantages and disadvantages of a backfilled tunnel versus an accessible tunnel.

---

## Summary of Feasibility Study for a Line 5 Tunnel under the Straits

### Tunnel consultants

Enbridge engaged the following consultants to study the feasibility of constructing a tunnel under the Straits.

#### Lead Engineering Consultant—Hatch:

- Hatch is a global, multidisciplinary engineering consultancy with 8,000 employees in 65 offices on six continents, with tunneling as one of its core strength specialties. To date, Hatch has engineered more than 1,000 miles of constructed tunnels in soft soils and hard rock by TBM and drill and blast mining.

#### Independent Consultant—Aldea:

- Aldea Services LLC is a leader in the underground construction industry. Aldea has planned, designed and constructed tunnel projects around the world.

#### Constructibility Reviewer—Michels:

- Michels Corporation is an industry-leading utility contractor that provides a wide range of services, including pipeline construction and tunneling.

#### Environmental Impact Consultant—Stantec:

- Stantec is an international engineering, environmental and technical services firm with five offices in Michigan. Their 2,700 North American environmental services staff and environmental sciences practice works with clients to assess environmental impacts, evaluate project requirements and prepare environmental assessments to meet regulatory standards.

#### Independent Environmental Impact Consultant—AECOM:

- AECOM's global environmental services practice is made up of more than 10,500 professionals specializing in 100+ topics, including impact assessment and permitting.

### Tunnel feasibility

Hatch, Aldea and Michels concluded that tunnel construction is feasible along the proposed Straits of Mackinac tunnel path between tie-in points near the existing Enbridge North Straits Station on the north shore and the existing Enbridge Mackinaw Station on the south shore. The exact locations of the portals would not be determined until the next phase of design, but this does not impact Hatch's overall determination that a tunnel is feasible.

Hatch based its feasibility study on current tunnel and pipeline design practice, standards for bored tunnels, and local considerations to minimize impacts to nearby residents, the public and the environment. They stated that the proposed 12-foot outside diameter and approximate four-mile length of a Line 5 tunnel under the Straits would be well within the size and length range of pipeline tunnels constructed today.

Regarding design life, they stated that "some pipeline tunnels have been operating for more than 60 years, and that design life can effectively be indefinite with proper maintenance and inspection."

Hatch also set out to clearly define tunnel construction methodology, pipeline installation, constructibility, anticipated ground conditions, constraints, and the proposed tunnel plan and profile.

The scope of Hatch's feasibility study included assessing the merits and disadvantages of three tunnel options, as well as of backfilled versus open (accessible) tunnel concepts. The final decision on the type, configuration and dimensions of the tunnel would significantly impact the construction cost, schedule and preferred contract strategy.

## Tunnel configuration options

Hatch considered three configuration options for a Straits tunnel, using a Tunnel Boring Machine:

1. A curved TBM-bored tunnel under the lake bottom starting at a north-shore launch portal and finishing at a south-shore reception portal (portal-to-portal).
2. A shaft on each shore and a straight shore-to-shore TBM-bored tunnel under the lake.
3. A TBM-bored tunnel between one shaft and one portal.

Hatch, Aldea and Michels concluded that the portal-to-portal option (*Figure 11*) would be the most favorable in terms of constructibility, safety, cost and operational considerations.

*Figure 11: Illustration of the proposed tunnel configuration and construction sequence for a Line 5 tunnel.*

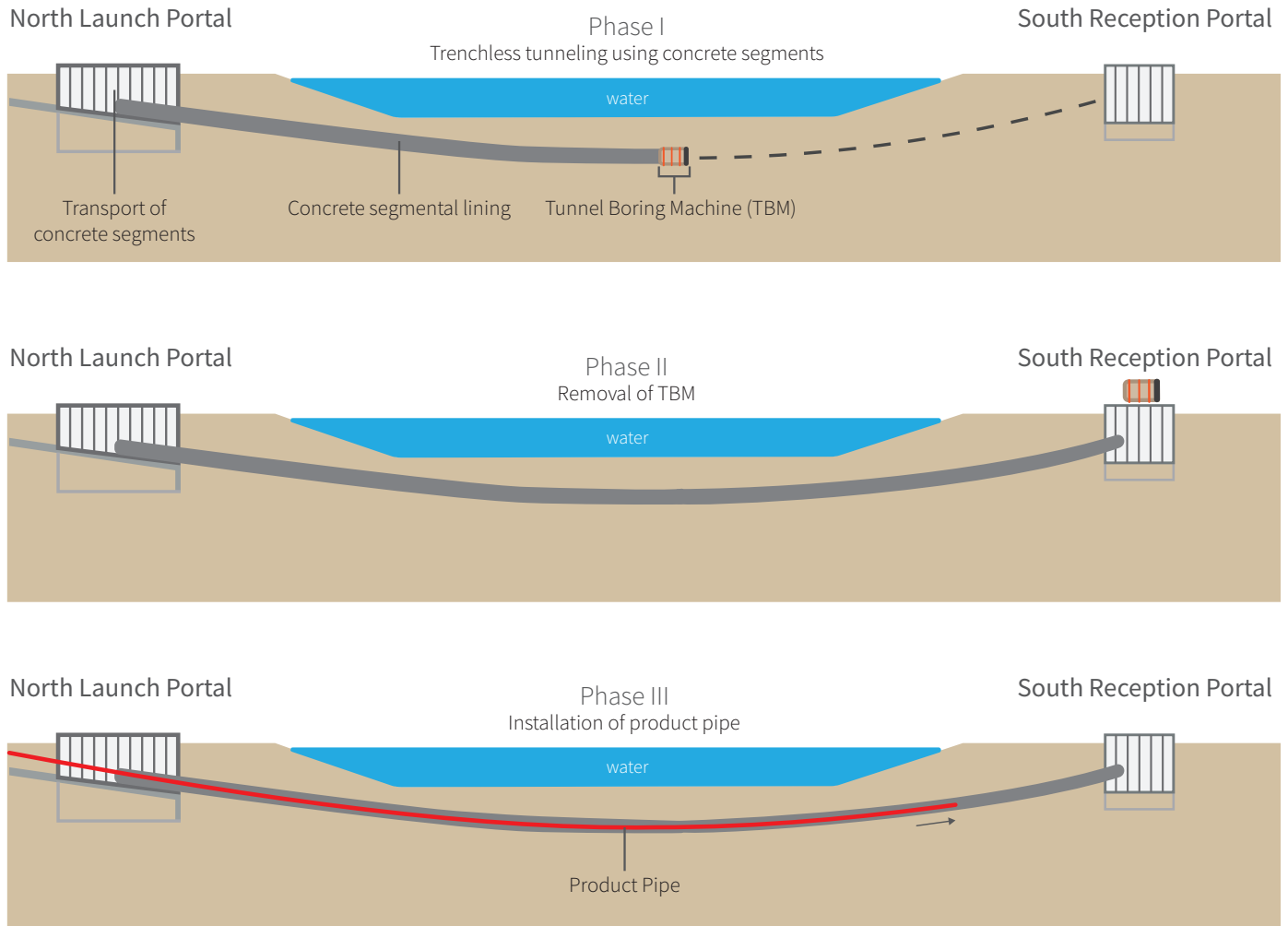

Hatch outlined the following advantages to the portal-to-portal option:

- By eliminating shafts, costs are reduced and work hazards—both during construction and during pipeline operation—are lowered. Shafts are expensive and time-consuming, with numerous critical-path construction activities that are more complex to execute within a shaft because almost everything requires using a crane—for example, mobilizing the TBM; removing excavated material; and delivering precast lining pieces and pipes into the tunnel.
- Vehicle access can be provided to both portals with a sloping ramp.
- The TBM and all trailing gear would be completely pre-assembled prior to excavation, which results in a faster start-up and improves overall construction time.
- Portals make pipeline installation easier. Tunnel access is provided through trenches without the need for special lifting equipment.
- Pipe installation would also be more efficient because the pre-welded pipe segments can be longer and then pushed into the tunnel.
- There is no need for 90-degree pipe connections or vertical pipes, which can be more difficult to construct, operate and inspect.

**Given Hatch’s recommendation of the portal-to-portal option, the remainder of this tunnel feasibility report focuses on that option.**

Please see *Appendix 1* for Hatch’s detailed plan and profile drawings for the portal-to-portal option.

### **Straits tunnel specifications**

Hatch recommends the following specifications for a Straits tunnel:

<b>Portals</b>	One north-shore TBM “launch” portal and one south-shore TBM “reception” portal.
<b>Tunnel length</b>	Approximately 22,000 feet (four miles), with a maximum slope of 4.6 percent.
<b>Maximum tunnel depth</b>	Approximately 350 feet below the lake surface and approximately 100 feet beneath the lakebed at its deepest point.
<b>Tunnel outer diameter</b>	At least 12 feet.
<b>Tunnel inner diameter</b>	At least 10 feet.
<b>Tunneling excavation method</b>	Tunnel boring machine. The TBM would drive from north to south (based on land availability, Enbridge ownership and public proximity considerations).
<b>TBM type</b>	Slurry Pressure Balance TBM.
<b>Tunnel lining</b>	Precast concrete incorporating high-strength gaskets.
<b>Pipeline size</b>	One 30-inch diameter pipe.
<b>Tunnel accessibility</b>	Open tunnel.

## Geological considerations

To determine the feasibility of a tunnel under the Straits, it is essential first to assess the geology of the area and to confirm that the geological conditions along the proposed tunnel path will ensure tunnel stability.

To obtain relevant regional and local geotechnical and geological data for the tunnel feasibility study, Hatch first carried out a desktop study. The study included the following sources: (1) drilling investigations conducted for the Mackinac Bridge from 1939 to the 1950s, 1.4 miles east of the pipeline, (2) former Michigan State Geologic Survey investigations of the Straits area, and (3) Michigan Department of Environmental Quality's GIS website GeoWebFace.

### What is a karst?

Karst features, such as open voids, form in areas where the underlying bedrock is composed of material that can be slowly dissolved by water.

Based on its study, Hatch concluded that bedrock along the proposed tunnel path is expected to consist of sedimentary limestone, dolomite and shale with potential karst voids in bedrock, along with some brecciated rock units. Overburden soils are expected to consist of lacustrine silt and clay, glacial till and boulders.

Hatch then extrapolated this information to develop a preliminary bedrock profile for the proposed tunnel path, and assumed the following for minimum bedrock cover along the tunnel path:

**Launch and reception portals:** Approximately 30-40 feet below ground surface and a minimum of approximately 10 feet below bedrock surface (Figure 12). These estimates are based on currently available geotechnical information regarding depth of overburden (soft soil) in the region of the portals.

- **Tunnel under the Straits:** Approximately 100 feet beneath the lakebed at its deepest point.

Figure 12: Illustration of the proposed north and south portals.

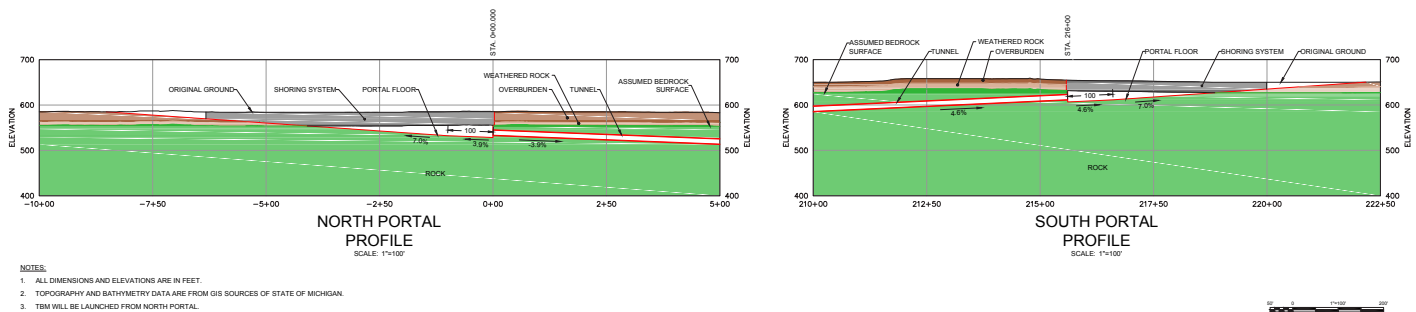

#### NOTES:

1. ALL DIMENSIONS AND ELEVATIONS ARE IN FEET.
2. TOPOGRAPHY AND BATHYMETRY DATA ARE FROM GIS SOURCES OF STATE OF MICHIGAN.
3. TBM WILL BE LAUNCHED FROM NORTH PORTAL.

To further support the tunnel feasibility study, a preliminary geotechnical investigation consisting of two vertical boreholes was completed in May 2018 on Enbridge's north and south shore properties to depths of 430 and 460 feet, respectively. The samples were sent for laboratory geotechnical tests.

Tunnels have been built successfully in a wide range of geological conditions, and based on its geotechnical analysis, Hatch said that "for the purposes of this feasibility study, the available geological information and proposed tunnel cover depth are considered acceptable." In other words, there is no indication of any conditions under the Straits that would prevent the successful construction of a tunnel.

Before tunnel planning and design could move forward, detailed geotechnical investigations would be carried out to define engineering design criteria. This work would include: groundwater sampling to investigate the groundwater quality; environmental characterization of the portal sites; seismic refraction surveys to investigate depth of bedrock; and drilling to identify soil and bedrock condition along the tunnel path. The latter would require drilling approximately 14 bore holes from a barge on the Straits and four bore holes on land. Before this drilling activity could begin, survey and geotechnical boring permits and approvals would have to be secured from the U.S. Army Corps of Engineers and the Michigan Department of Environmental Quality.



Also, as part of this feasibility study, preliminary satellite-based remote sensing and geospatial sampling was carried out to identify the top-of-soil and top-of-rock profile along the proposed tunnel path. This 3-D geological modeling used synthetic aperture radar to penetrate vegetation, overburden and water to identify soil and bedrock surfaces. Should the tunnel alternative move forward, results of this investigation could be cross checked and calibrated with the actual borehole data along the potential tunnel path to confirm geophysical data interpretations. This data would then be incorporated into the tunnel design, subject to confirmation of interpretive accuracy from borehole calibrations.

### Tunnel depth

#### What is competent rock?

Rock capable of withstanding an applied load under given conditions without falling or collapsing.

For tunnel stability, a suitable tunnel depth under the Straits must be achieved. This depth is typically based on a minimum acceptable thickness of competent rock above the tunnel crown or top. It relies on an accurate bedrock profile that would be obtained through a geophysical survey program, including marine and terrestrial surveys and boreholes along the potential tunnel path.

Based on the information currently available, Hatch estimates that the maximum depth of the tunnel along the tunnel path would be approximately 350 feet below the lake surface (Figure 13). This could create a hydrostatic water pressure at tunnel level under the deepest part of the channel of approximately 174 psi (12 bar). Such high-pressure tunnel designs have been completed before, for example at 230 psi for the Lake Mead Water Intake Tunnel in Nevada and at 174 psi for the Eurasia Road Tunnel underneath the Bosphorus Strait in Istanbul.

Figure 13: Illustration of proposed Line 5 tunnel beneath Lake Michigan. Elevations are referenced to mean sea level (msl).

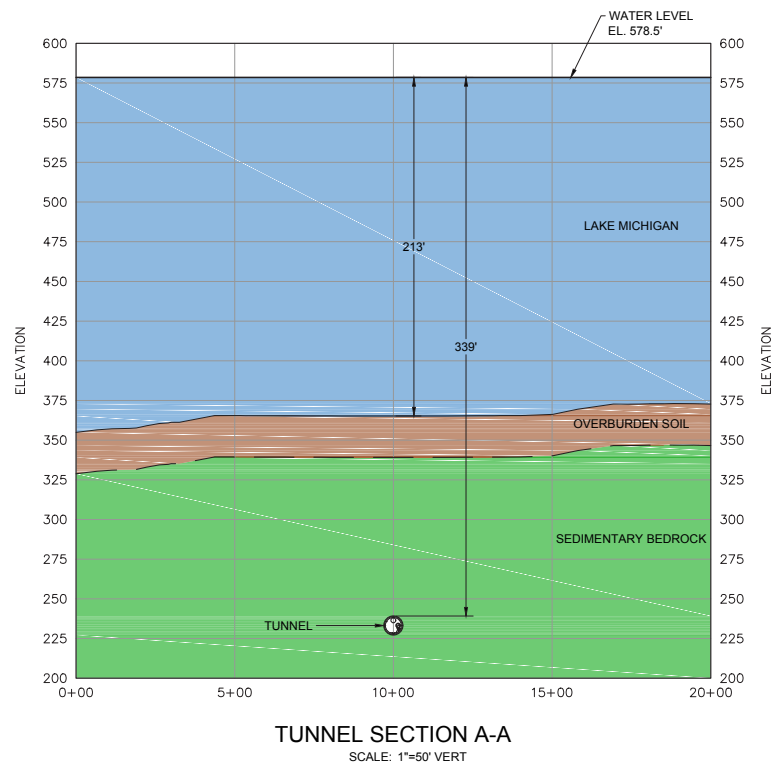

## Tunnel diameter and lining

Hatch proposes an open, accessible Straits tunnel with an internal diameter of at least 10 feet after installation of a precast concrete tunnel lining (Figure 14). Both the Lake Mead and Eurasia tunnels used PCTL.

The PCTL would incorporate high-strength gaskets and the annulus outside the lining would be grouted. The pipeline would be supported within the tunnel and there would be sufficient space for inspection of the pipeline. In the unlikely event of a release from the pipeline, the tunnel would act as a secondary containment system.

A tunnel with a 10-foot internal diameter would require a TBM with at least a 12-foot outside diameter (Figure 15). In recommending this size of TBM, Hatch considered expected variability of ground conditions and geological hazards such as karst or unstable rock conditions.

The proposed tunnel diameter is commensurate with standard tunnel construction equipment. Tunneling method and TBM size would be further evaluated during detailed design.

Figure 14: Left—tunnel section showing the internal features of an open, accessible Straits tunnel with the 30-inch pipeline mounted on a pipe-support saddle. Right—a precast concrete tunnel lining segment.

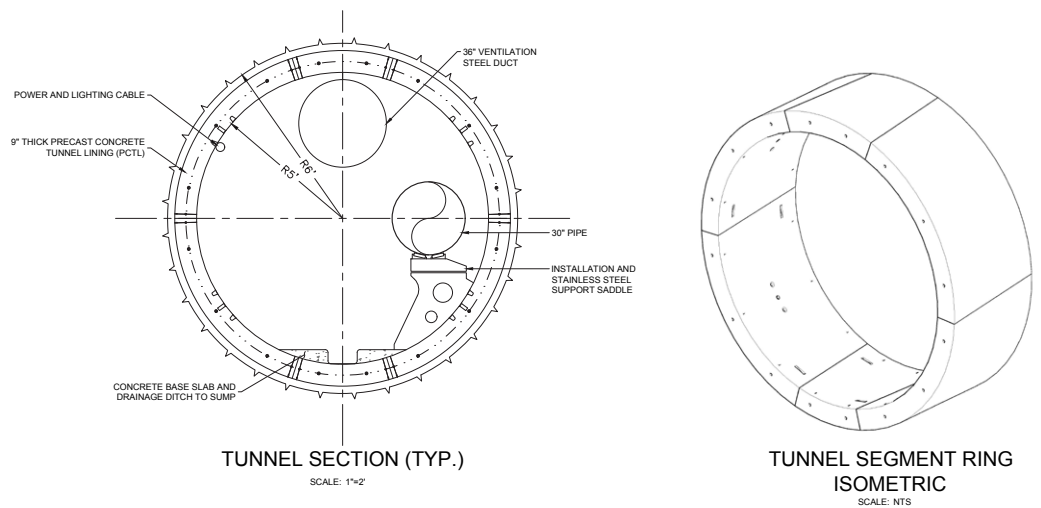
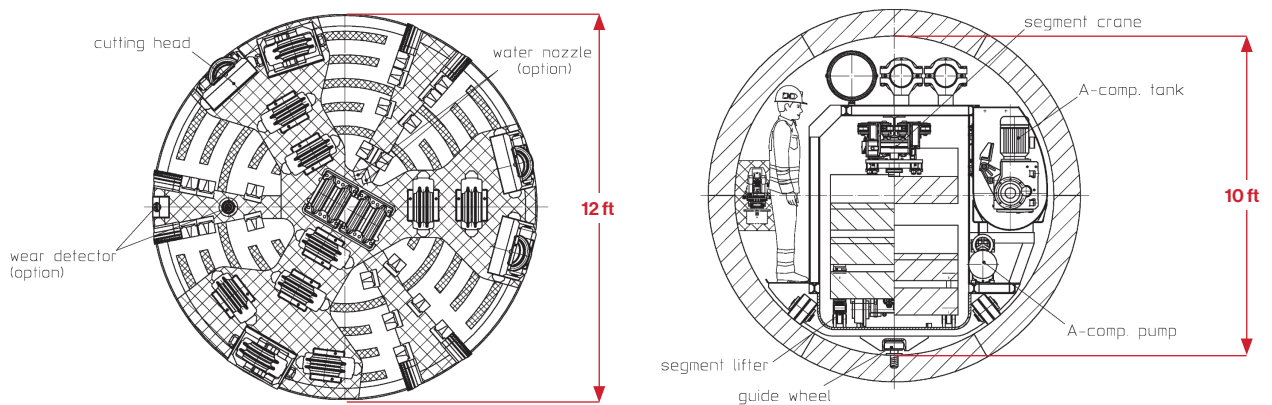

Figure 15: TBM sections—cutting wheel (left) and control cabin (right) (Source: Herrenknecht)





## Placing other utilities in the tunnel

While increasing the TBM size to accommodate future third-party utilities is not specifically considered in this report, Hatch confirmed that increasing the tunnel size would not impact the feasibility of tunneling under the Straits. Tunnels are scalable in size and can be designed to accommodate a variety of services. For a Straits tunnel, it would be critical to understand before design and engineering begins whether the tunnel could have a purpose beyond the pipeline, such as for third-party services/assets, and specifically risks associated with co-locating different types of infrastructure. A scope change of this magnitude just before construction would limit or potentially eliminate the options for accommodating additional services.

## TBM type

Selection of TBM type is based mainly on the anticipated ground conditions. Given what is known about the geologic conditions at the Straits, a pressure balance TBM—also called a pressurized face TBM—is the best option. It is capable of exerting a balancing pressure against the tunnel face in front of the cutterhead to prevent groundwater inflow. Pressure balance TBMs are very specialized and are available from a limited number of manufacturers worldwide.

The two most common types of pressure balance TBMs are:

1. **Earth Pressure Balance (EPB) TBM**, which is commonly used in cohesive soils with low to moderate groundwater pressure.
2. **Slurry Pressure Balance TBM (Slurry TBM)**, which is often used for tunneling in water-bearing granular soils and highly jointed rock with high groundwater hydrostatic pressure.

Given the potential high groundwater pressures and anticipated variable ground conditions under the Straits, Hatch proposes that a Slurry TBM would be the preferred option. Slurry TBMs can handle water pressures of up to 230 psi (16 bar), which would provide a significant safety margin for tunneling under the Straits, where the water pressure at tunnel level under the deepest part of the channel could be approximately 170 psi (12 bar).

A Slurry TBM would include probe-hole drilling and pre-excavation grouting technology so that the ground ahead of the TBM face could be sealed up if needed.

Also, Slurry TBMs are equipped with alarm sensors for hazardous gases and components to remove any gases safely from the tunnel. Slurry TBMs offer further protection from gases by containing the excavated material in pipes, rather than a conveyor, until it has been removed from the tunnel. This is important because research of historical records for the Straits indicates potential hazards from explosive gases, including methane and hydrogen sulfide.

If a Slurry TBM is deployed, then bentonite slurry would be used. Bentonite is a non-toxic substance composed of clay minerals that swell considerably when mixed with water. Bentonite slurry serves three purposes in tunneling. It acts as a lubricant to assist the TBM in excavating the tunnel, as a seal that supports the tunnel face, and as a medium for transporting excavated material away from the tunnel face.

Further, bentonite is a common clay material used in landfill liners as a containment layer due to its low permeability. Therefore, the bentonite will also act as a containment system because it penetrates into the rock structure surrounding the tunnel. In the unlikely event of hydrocarbon release, bentonite will also act as an absorbent for hydrocarbons. It is highly unlikely, if not impossible, for bentonite to migrate into the lakebed because Slurry TBMs include features that are designed to prevent this from occurring.

TBM selection would be further evaluated during tunnel design once geotechnical-drilling and geophysics data become available. Each type of TBM has its advantages and disadvantages, and the type selected would affect the cost and schedule.

### Approximate construction sequence

1. Development of a north laydown area, which would include ground clearing, grading and fencing.
2. Excavation and ground support for the north portal entrance. This would involve ground excavation, limited blasting, grouting/ground improvement and shoring, and installation of related infrastructure (water retention pond, etc.).
3. Delivery and storage of segmental precast concrete tunnel lining.
4. Delivery, assembly and launch of the TBM.
5. TBM tunnel excavation, waste rock and water management, etc.
6. Land clearing, grading and fencing on the south shore approximately six months prior to tunnel breakthrough.
7. Excavation and ground support for the south portal entrance. This would involve ground excavation, limited blasting, grouting/ground improvement and shoring, and installation of related infrastructure (water retention pond, etc.).
8. Receiving and assembly of pipeline material. This would involve spooling (welding) activities approximately two months prior to tunnel completion. At this time, it is proposed that only the north side be used for this purpose as a means of minimizing disruption on the south side.
9. TBM breakthrough on south shore area, disassembly and removal from site.
10. Pipeline installation, tie-ins to existing lines and pressure hydrotesting of the pipeline.
11. Permanent systems installation (ventilation, lighting, etc.).
12. Restoration of areas surrounding the portals and laydown areas.

### TBM launch and reception

The TBM (cutterhead, shield and trailing gear) would be assembled at the surface on Enbridge land on the north shore in a shallow launch portal, which is the opening to the tunnel. The portal would be excavated to approximately 30 to 40 feet below ground surface and a minimum of approximately 10 feet below bedrock surface (*Figure 16*).

Enbridge owns 50 acres at the north portal, and about 10 to 15 acres would be needed to accommodate the staging area, hydrostatic testing of the pipeline, use and storage of tunneling equipment, and other construction activities.

As little as two acres at the south shore would be required for the TBM reception portal. The location of the reception portal would be subject to further study, but options could include Enbridge-owned land at Mackinaw Station, or on land purchased or leased from third parties.

*Figure 16: A TBM with cutting wheel (foreground) and trailing gear being launched via a launch portal for the Niagara Hydroelectric Project in Ontario.*



## Spoil handling and disposal

The tunnel project would generate both surface and tunnel spoil of soil and broken rock, respectively.

Regarding surface spoil, reusable topsoil would be stockpiled locally and returned during site restoration. Any topsoil and overburden not suitable for reuse would be stockpiled separately and removed for disposal.

Regarding tunnel spoil, rock cuttings from the tunnel may be of good quality and have use as a structural fill. Any cuttings not suitable for reuse would be stockpiled separately and removed for disposal.

Bentonite slurry used by the Slurry TBM would be removed from the tunnel via a slurry pipeline and processed at the surface to separate the bentonite from the excavated material, which would be stockpiled on site. Cleaned bentonite slurry is returned to the TBM's cutting chamber for reuse.

There are several potential muck disposal sites with capacity and reasonable haul distances from the Straits tunnel construction site. Although none is currently identified, any contaminated material could be handled at an appropriate facility.

A preliminary estimate of excavated soil and bedrock (muck/spoil) indicates that the volume of the generated muck at the north side would be about 200,000 cubic yards from portal and tunnel excavations, and volume on the south side would be about 50,000 cubic yards from portal excavation only.

## Pipeline installation

Once the tunnel has been constructed, installation of the 30-inch pipeline can be done through a variety of methods. Hatch considered two options:

1. Welding of pipe joints at portals via production line means, and incremental pushing/pulling of the pipeline through the tunnel.
2. Refabrication of long pipeline strings at the portals and pushing/pulling these strings through the tunnel, stopping only for joining welds (*Figure 17*).

The best option would be determined in the next phase of design should this alternative move forward.

*Figure 17: Section of welded pipe string being lifted onto rollers in preparation for being installed in tunnel.*



---

## Independent Assessment of Hatch's Tunnel Feasibility Study

### Independent Consultant's Conclusions

Aldea Services LLC, a leader in the underground construction industry and the Independent Consultant assessing Hatch's feasibility study, stated the following:

*"Our overall assessment is that Hatch's feasibility study for a tunnel under the Straits of Mackinac is very well-considered and accurate, and we concur with Hatch's assessment that a Straits tunnel is feasible."*

### Constructibility Reviewer's Opinion

In its opinion letter, Michels, an industry-leading utility contractor and the Constructibility Reviewer of Hatch's tunnel feasibility study, stated the following:

*"Based on the information provided within this report and upon review of the other information provided by Enbridge, Michels is in full agreement with Hatch that this project is feasible."*

---

## Construction Cost Estimate

Estimated capital cost:  
US\$350 – 500 million

The estimated capital cost for the portal-to-portal construction option—using one TBM and a tunnel built to specifications outlined above—is US\$350 – 500 million. This total installed cost includes completing the tunnel, installing pipe within the tunnel, tie-ins from tunnel portals to the existing 30-inch pipeline, property acquisition that may be required and internal costs.

---

## Project Execution Schedule

Estimated total project execution schedule is 5 to 6 years

The estimated time to secure all approvals (a description of the permits required can be found in the Permits and Approvals section below), procure materials and construct the tunnel is about five to six years. This includes completing all environmental surveys, the offshore geotechnical program, preparing applications and completing detailed design. On-site construction activities occupy slightly less than the final three years. Of the three-year construction duration, about two years is allowed for tunnel boring.

Please see *Appendix 4* for a high-level schedule.

---

## Tunnel Permits and Approvals

We assume that it will take about two years to secure all the permits and authorizations to build a tunnel.

The tunnel would require at least 15 state and federal permits. The primary regulators would be the U.S. Army Corps of Engineers, Michigan Department of Environmental Quality, Michigan Department of Natural Resources and Michigan Public Service Commission.

The permits and approvals that would be required address the following features and issues:

- Geotechnical investigations
- Wetlands
- Great Lakes and Connecting Waters Intermittent Stream
- Environmental Areas—public, state or federal
- Protected Species
- Cultural Resources
- Soil Erosion
- Special Use Permit
- Noise and Lighting
- Stormwater Discharge
- Hydrostatic Pressure Test
- Great Lakes Shipping Channel—Marine Traffic
- Certificate of Public Convenience and Necessity

It would also require several local permits—such as zoning, building, special use, etc.—from Moran Township, City of St. Ignace, Emmet County and Mackinaw City.

Should this alternative move forward, Enbridge would consult with the appropriate agencies on the proposed design and scope of work. Specific permitting durations would be determined and confirmed after consultation with agencies.

A list of the most likely permits and approvals is included in *Appendix 5*.

---

## Tunnel Risk Assessment

Hatch states:

*“Ground conditions dictate the appropriate construction method. Since tunnels are linear and accessible only from the ends, there are limited opportunities to work around a problem if the construction method is unsuitable for the conditions encountered. As such, risks need to be considered at every design stage and dealt with in an appropriate manner to provide safe working conditions and reduce risk of delays and cost over-runs.”*

A preliminary risk assessment was carried out during the feasibility study. Should the tunnel option move forward, a more detailed risk assessment will be developed. This would consist of risk workshops to facilitate updates to the risk assessment, including the following tasks:

- Identifying potential risk events that could affect project outcomes.
- Assigning probability of occurrence to each risk event.
- Assigning severity of occurrence to each risk event, should it occur.
- Developing risk response strategies to control or mitigate adverse impacts.
- Identifying risk events that require further analysis.
- Assigning ownership of risks and defining how they will be managed.
- Tracking all open actions until they are closed.

In their reports, both Hatch and Stantec addressed various risks, as follows:

### Geologic hazards

**Rock quality:** As previously stated, the main geologic risk is uncertain ground conditions and tunnel stability during and after construction. This risk would be mitigated by the technologically advanced Slurry TBM and the precast concrete tunnel lining (PCTL), both of which are designed to meet all anticipated ground conditions.

**Groundwater inflow:** During construction, there is potential that the TBM would encounter open joints and karst voids, which could cause groundwater flooding of the tunnel if it were not properly designed. This risk would be managed with two different measures: (1) selecting a Slurry TBM that can handle the groundwater flooding and pressure greater than the overlying groundwater pressure in the Straits (as previously stated, the water pressure anticipated at the deepest part of the channel is 174 psi (12 bars)); and (2) install probe-hole drilling and pre-excavation grouting technology on the TBM so that the ground ahead of the TBM face could be sealed up if needed.

**Uncertainty about the depth of the mid-channel valley in the Straits:** A lake depth survey suggests a deep channel in the middle of the Straits. Should the tunnel alternative move forward, a geotechnical investigation will be carried out to determine actual depth and lakebed topography. The Slurry TBM recommended by Hatch was selected specifically to allow for variable ground conditions. Moreover, to mitigate the risk of hydraulic connection between the tunnel and lake, the Slurry TBM and PCTL tunnel lining would be designed to provide a safe and secure work place during construction.



**Explosive and toxic gases:** Research of historical records indicate potential hazards from explosive gases, including methane and hydrogen sulfide. A Slurry TBM provides a closed system so that gases in the excavated material are completely isolated within pipes until the material reaches the slurry separation equipment on the surface. As a result, the workers in the TBM are not exposed to these gases. As a backup, the TBM also has alarm sensors to alert workers of hazardous gases, and the tunnel is ventilated to manage these hazards. Tunnel ventilation would be designed to meet regulatory and industry thresholds.

**Karstic features with open voids:** Karst features may pose a risk for tunneling due to excessive water inflow and tunnel instability. This can be mitigated using a Slurry TBM with pre-grouting capability.

**Seismic geohazards:** The State of Michigan is considered a region with very low risk of major earthquake. Stantec reports that northern Michigan, including the Straits area, is not considered to be tectonically active. The Central and Eastern U.S. Hazard and Seismicity map (USGS 2014) indicates that the earthquake hazard risk in the Straits is 2 on a scale ranging from 1 (lowest risk) to 15 (highest risk). Hatch reports that risk of seismic geohazard is considered very low along the proposed tunnel path below the Straits. Moreover, tunnels are routinely designed to withstand seismic activity (for example, high-speed rail tunnels in Japan) and all design codes would be met/exceeded for a Straits tunnel. There are currently no indications that the path of a Straits tunnel would cross any fault lines. However, this would be subject to further geotechnical/geological investigation should the tunnel alternative move forward.

**Isostatic rebound:** Isostatic rebound is the rise of land masses that were depressed by the weight of ice sheets during the last glacial period through a process known as isostatic depression. The entire North American continent is moving both horizontally (west) and vertically (both up and down). The Straits are just north of the “hinge line” that separates upward (isostatic rebound) and downward motion. Dr. Stanley Vitton, the independent geotechnical engineer on the alternatives feasibility assessment team, suggested that the strain induced in the plate over a distance of five miles would be undetectable. Hatch states that post-glacial rebound uplift is too small to impact stability of a tunnel under Lake Michigan, and that modern bored tunnels are designed to accommodate any expected ground movements and remain stable.

# Alternative: Open Cut with Secondary Containment

Feasible

Enbridge has concluded that installing a new pipeline using the open cut construction method and featuring a pipe-in-pipe secondary containment system and covered with six to eight feet of engineered protective cover is a feasible alternative for the Straits of Mackinac crossing. INTECSEA, the Lead Engineering Consultant for this alternative, states that by applying tried and tested methods of installation, a new pipeline can be safely installed across the Straits of Mackinac using this construction method.

- **Estimated cost:** \$250 – 300 million
- **Estimated timeline:** 4 to 5 years

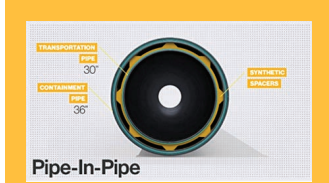

To view an animation and graphic illustrating construction of a pipeline across the Straits of Mackinac using the open cut construction method and featuring pipe-in-pipe secondary containment, please visit [enbridge.com/L5Alt](http://enbridge.com/L5Alt)

## Highlights of the ‘Open Cut with Secondary Containment’ Alternative

	Open cut with secondary containment
Enbridge’s opinion	Feasible
Lead Engineering Consultant’s opinion	Feasible
Independent Consultant’s opinion	Feasible
Constructibility Reviewer’s opinion	Constructible
Estimated cost	\$250 – 300 million
Project timeline (including planning, design, permitting and construction)	4 to 5 years* * Schedule would be sensitive to seasonality. Please see Appendix 4 for details.
Pipeline location	Trenched to 30 feet of water depth (approximately one-half mile offshore); remaining length laid on the lakebed and covered in engineered protective cover. From the top of the pipe, the protective cover would be six- to eight-foot thick.
Secondary containment feature	Pipe-in-pipe system with the 30-inch product-carrying pipe contained within a 36-inch outer containment pipe.
Risk of product leak from pipeline reaching Straits water	The secondary containment design of the pipe-in-pipe system combined with the engineered protective cover reduces the probability of a release into the Straits to a very low value.
Potential environmental impacts	<b>Construction:</b> Impact to shorelines likely to be considered minimal; impact to lakebed may not fit the definition of minimal individual and cumulative adverse environmental effects—likely would require an Individual Permit. Onshore work space needs six to eight acres on north shore and one to two acres on south shore. <b>Operations:</b> Disturbed onshore areas would be reclaimed after construction; no new significant above-ground permanent facilities anticipated.
Incident prevention	24/7/365 monitoring and regular inspections of both the internal product pipe and the engineered protective cover.
Pipeline accessibility and maintenance	If the pipeline needs to be accessed at any location, the engineered protective cover can be removed by means of subsea construction equipment and divers. If repairs are required, they would be challenging due to depth of water and the pipe-in-pipe system.



## Overview of the Open Cut Construction Method

To replace Line 5 at the Straits using an open cut method, many key construction and design factors that influence open cut project planning were considered in the context of the unique site characteristics of the Straits. Some of the key factors are described in the table below:

### Key Factors that Influence Open-cut Planning\*

Key Factor	Planning Consideration
Open cut pipeline construction method	Consideration was given to installing the pipeline either wholly in a trench—or partially in a trench and partially on the lakebed. The objective is to ensure both reliability/integrity of the pipeline and to minimize environmental impacts.
Route selection	Lakebed topography, subsoil characteristics, rock outcrops, avoidance/minimization of spans, environmental considerations, installation constraints, and existing onshore and lakebed infrastructure are among the factors Enbridge would analyze when selecting the route.
Secondary containment	Over the last two decades, the pipe-in-pipe (PIP) system has become widely used for subsea oil and gas transportation. The PIP system is achieved by placing a primary product-carrying pipe into an outer pipe. Specific to the Straits, a PIP system would be used to satisfy secondary containment requirements.
Mechanical design, which includes:	
<ul style="list-style-type: none"> <li>Anchor drop and drag protection</li> </ul>	<p>Optimize burial/cover requirements based on lakebed topography, subsurface and geotechnical data.</p> <p>Optimize design based on maximum anchor size, geotechnical data and model tests, supplemented by numerical models.</p>
<ul style="list-style-type: none"> <li>Wall thickness</li> </ul>	Wall thicknesses for the PIP system should provide a robust design and maintain flexibility for construction.
<ul style="list-style-type: none"> <li>Corrosion protection</li> </ul>	The outer pipe will be protected using appropriate cathodic protection systems, and the inner pipe by corrosion protection coating. Several such installations are in operation worldwide and are protected in a similar way.
<ul style="list-style-type: none"> <li>Shore approaches and burial design</li> </ul>	Consideration to both the environmental impact of trenching—especially near shore—and the need to cover the pipeline.
<ul style="list-style-type: none"> <li>Long-term integrity and monitoring</li> </ul>	Design must comply with Enbridge's existing integrity monitoring system and all regulatory requirements to ensure continued safe operation of the system.

\* Other terms used to describe an open cut installation are 'conventional lay' and 'conventional crossing'.

---

## Summary of Feasibility Study for Installing a Pipeline across the Straits using the Open Cut Construction Method with a Pipe-in-Pipe Secondary Containment System

### Open cut consultants

Enbridge engaged the following consultants to study the feasibility of the open cut alternative:

#### Lead Engineering Consultant—INTECSEA:

- INTECSEA, Inc. is a provider of engineering services that has designed subsea production systems, pipelines and floating systems for offshore field development and pipeline projects in the Gulf of Mexico, Arctic Ocean, North Sea, offshore Western Australia, Mediterranean Sea, Black Sea, offshore West Africa and South China Sea.

#### Independent Consultant—Project Consulting Services (PCS):

- PCS is a pipeline and pipeline facility engineering and regulatory compliance firm whose scope of expertise includes navigating U.S. Army Corps of Engineers and Bureau of Safety and Environmental Enforcement regulatory processes efficiently and engineering deepwater subsea tie-ins. The review provided by PCS for this report was from the Regulatory Compliance perspective.

#### Constructibility Reviewer—Michael Baker International/Kokosing Industrial's Durocher Marine Division:

- Michael Baker International is a leading provider of engineering and consulting services, including design, planning, architectural, environmental, construction and program management. Since 1940, the company's multidisciplinary teams have successfully delivered services to oil and gas industry clients.
- Kokosing Industrial is one of the largest contractors in the U.S. Midwest, serving the power, oil and gas, industrial, marine, heavy civil, water/wastewater and commercial sectors. Their Durocher Marine Division provides construction services for activities above or below water. Based in northern Michigan, Durocher Marine performed some of its first work near the Mackinac Bridge in the 1950s.

#### Environmental Impact Consultant—Stantec:

- Stantec is an international engineering, environmental and technical services firm with five offices in Michigan. Their 2,700 North American environmental services staff and environmental sciences practice works with clients to assess environmental impacts, evaluate project requirements and prepare environmental assessments to meet regulatory standards.

#### Independent Environmental Impact Consultant—AECOM:

- AECOM's global environmental services practice is made up of more than 10,500 professionals specializing in 100+ topics, including impact assessment and permitting.

### Open cut feasibility and design options

As described in the table *Key Factors that Influence Open-cut Planning* on page 29, INTECSEA's feasibility study focused on the following five key aspects of open cut pipeline design and construction that also included a pipe-in-pipe secondary containment system:

1. Open cut construction method.
2. Route selection.
3. Secondary containment.
4. Mechanical design.
5. Long-term integrity and monitoring.

Each of these design aspects has a direct influence on the pipeline's safety, integrity and impact on the environment.

INTECSEA concluded that the proposed 'open cut with secondary containment' pipeline system is feasible. INTECSEA also concluded that the pipeline's mechanical design will be able to withstand environmental, operational and accidental loads due to anchor drop and drag.

It was also determined that a single 30-inch product pipeline could be constructed to replace the current 20-inch dual Line 5 pipelines.

### Open cut construction method

INTECSEA considered two open cut pipe construction options:

1. Trenching the pipeline from the shoreline to a water depth of 30 feet on both the north and south shores to accomplish six feet of cover over the top of the pipeline. The remainder of the pipeline would lay on the lakebed and be covered with an engineered protective cover made of gravel and cobble; from the top of the pipe, the protective cover would be six- to eight-feet thick.
2. Trenching the entire pipeline—from the north shoreline to the south shoreline.

Based on their extensive design and construction experience with offshore pipeline projects around the world, INTECSEA recommends Option 1. Compared with trenching the entire crossing, Option 1 would reduce environmental impacts, construction risks, construction schedule, and cost, while maintaining project quality and long-term pipeline integrity.

### Why is trenching the entire length of lakebed not the preferred option?

INTECSEA determined that trenching the lakebed the entire length of the pipeline is not practical for the following reasons:

- Trenching the lake bottom would be testing the limitations of trenching equipment, given both the depth of the Straits at its deepest point of 250 feet and the high likelihood of hard soils on the lakebed.
- There is potential for high environmental impact, considering the amount of excavated/dredged material and the resulting water turbidity.
- Managing the dredged material would be complex, given the volume, which introduces environmental risks.
- Construction would likely interfere with Straits ship traffic and local recreation/fishing.
- The construction period would take longer, likely requiring more than one season of construction.

Most importantly, INTECSEA states that trenching the entire length of the pipeline provides little benefit in protecting the pipeline from anchor strike because a trenched pipeline would still require an engineered protective cover to achieve the desired protection from an anchor strike.

**Given INTECSEA's recommendation of using a construction method that combines both trenching the shorelines and laying the pipeline on top of the lakebed (option 1), the remainder of this feasibility report focuses on that scope.**

### Pipeline installation

When considering the methods for installing 30- x 36-inch pipe-in-pipe (PIP) systems over four miles across the Straits, the options are limited because of the locations and marine equipment available in the Great Lakes.

To install the PIP system, INTECSEA recommends using a 'bottom-pull' method. After 60+ years, the bottom-pull method of pipelay across lakes and rivers is still an accepted and preferred method for pipeline installation (*Figure 18*). It would shorten the pipeline installation time, thereby reducing marine-traffic restrictions and delays. It is also the option that has the least environmental impacts, and it allows for the PIP segments to be welded onshore, which is more efficient than welding off a barge.

#### What is cobble?

A type of rock defined as having a particle size of one to 12 inches; larger than a pebble and smaller than a boulder.

Figure 18: Pull wire set up for typical open cut shore crossing.



Generally, the bottom-pull installation method involves stringing the pipeline onshore, then pulling it across the Straits, using a cable via a winch from the opposite shore. The pipeline would remain in contact with the lake bottom during the pull installation via buoyancy-control measures. Buoyancy modules would be used to reduce the weight of the pipeline and pulling forces.

Surface marine support vessels would be needed to monitor the pipeline while it is being pulled across the Straits. The Coast Guard would also be notified, and shipping traffic would need to be restricted to an agreed passage distance from the pipeline support vessels' positions.

The pipeline would be pre-fabricated on the north shore in the longest-possible lengths (pipe-stalks) (Figure 19). The preferred pipe-stalk length is approximately 4,400 feet, and at least five, 4,400-foot long pipe stalks would be fabricated.

The lakebed topography along the proposed pipeline route is likely to be irregular. Before the pipe-in-pipe system is installed by bottom-pull method, all the areas of high points and depressions would have to be either leveled by selective dredging or filled with gravel. After pipeline installation, a survey would be performed to ensure there are no spans along the route. Any locations that showed minor spans would be further remediated with gravel. Additionally, the adjacent lakebed depressions on either side of the proposed pipeline route would be leveled to provide an even base for the engineered protective cover.

Figure 19: An onshore pipe staking set up.



## Onshore work spaces

Onshore workspaces would be required on both the north and south shores.

The north shore would be used to weld, coat and string the pipeline, as well as for other necessary construction activities. This staging workspace area is anticipated to be approximately six to eight acres in size, and would be set back a short distance from the shoreline to help maintain a buffer to the water's edge.

Extending from the workspace to the north would be an approximate 5,000-foot stringing area, approximately 70 – 150 feet wide. Existing utility rights-of-way on the north shore could be used for some of the stringing area.

The south shore workspace would contain the winch to pull the pipeline across the Straits, as well as support equipment. The size of the workspace area is estimated to be approximately one to two acres. This workspace would be set back a short distance from the shoreline to help maintain a buffer to the water's edge. An approximate 10- to 15-foot-wide excavation would connect the south shore workspace to the shore and extend approximately 100 feet into Lake Michigan. The shore approach trench would be sheet piled as far as practical to reduce the dredging quantity, thereby reducing the environmental footprint. The winch would be powered by either diesel generators or electrical power.

## Pipeline route options

The exact location of the replacement pipeline, and where it would connect to the north and south shores, would be determined during the next phase of design should this alternative move forward. Preliminary analysis suggests the new pipeline would originate and terminate near the existing Enbridge North Straits Station on the north shore and in close proximity to the Enbridge Mackinaw Station on the south shore (*Figure 20*).

The routing of the pipeline would comply with regulatory requirements and be optimized to avoid any known natural hazards, such as debris, archaeological resources, geohazards, and marine organisms on the lakebed. Other considerations for the route selection are:

- Avoiding areas such as lakebed depressions, rock outcroppings, and other underwater hazards.
- Lakebed topography (optimizing with respect to installation, shore approaches, minimizing/avoiding spans, etc.).
- Maximizing installation logistics by securing adequate temporary workspace for pipe stringing and bottom-pull equipment.
- Minimizing impact on the environment, flora and fauna.
- Minimizing impact on the lakebed (minimal dredging).
- Avoiding risk to existing facilities such as power lines, communication lines, and other pipelines.
- Minimizing impact on commercial and recreational shipping.
- Tie-in locations of the new pipeline to existing Enbridge facilities.



Figure 20: The proposed open cut pipeline corridor is shown within the hatched area in this illustration. The precise pipeline route, likely within the corridor, would be determined in the next phase of design.

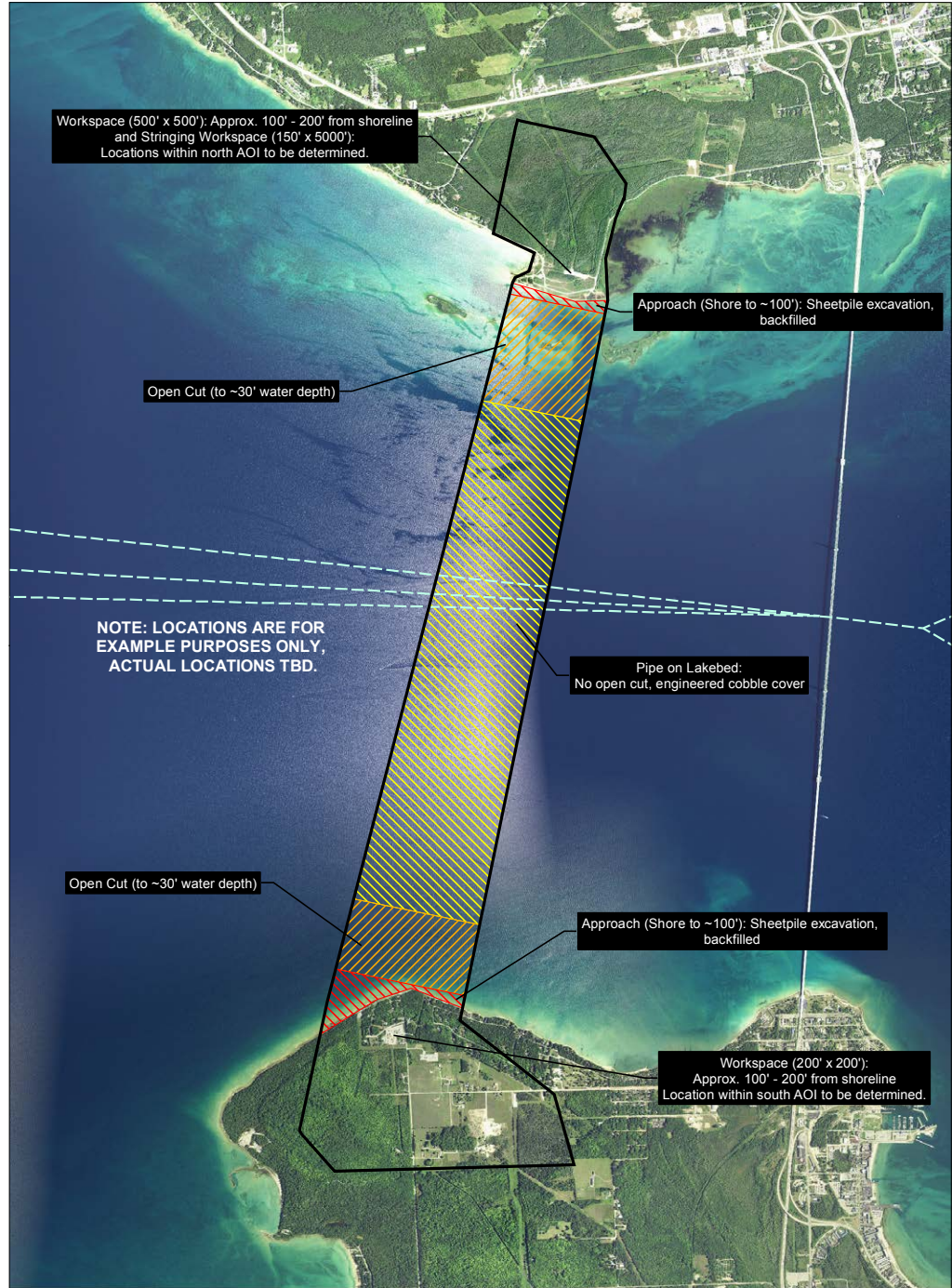

- Legend**
- Area of Interest
  - Typical Shipping Channel Traffic
  - Open Water Construction Segment
  - Approach
  - Open Cut
  - Rock Cover

0 0.25 0.5 Miles  
1:31,680 (At Original document size of 11x17)



## Secondary containment: pipe-in-pipe system

Secondary containment is an essential feature of the open cut alternative. It would be achieved by installing a pipe-in-pipe (PIP) system. The PIP would be a 30-inch steel products pipeline installed inside a 36-inch outer (containment) pipeline. The space between the two pipelines would contain synthetic, low-friction spacer rings to separate the two pipelines and help prevent damage and wear to the inner pipe and its coating (Figure 21).

Pipe-in-pipe systems are common and used worldwide for various objectives, including protection of pipelines, secondary containment and thermal insulation. There are several pipe-in-pipe systems existing in the Gulf of Mexico, offshore North Slope of Alaska, the North Sea, West Africa and many other locations globally.

This PIP system would minimize the risk of a leak into the Straits. In addition to providing secondary containment, the 36-inch outer pipe would include a leak detection system, enabling continuous real-time monitoring of the 30-inch inner pipe so that any leak from it can be easily identified and immediate action can be taken, including shut-down of the system.

The 36-inch secondary containment pipe would be designed to withstand internal pressure above the maximum operating pressure.

The PIP system would transition to the single Line 5 pipeline on either side of the Straits by the use of pipe-in-pipe steel “bulkheads”.

Figure 21: Proposed pipe-in-pipe system configuration.

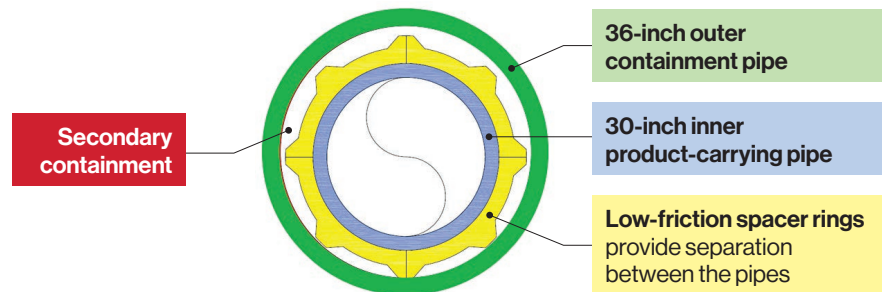

## Mechanical design considerations

### The shipping channel in the Straits

There is an existing shipping channel in the Straits. As the channel approaches the Mackinac Bridge, it narrows so that vessels travel between the four central piers of the bridge (Figures 22 and 23). This part of the channel is marked by four navigation buoys—two on each side of the channel. The central portion of the bridge provides the maximum vertical clearance between the surface of the lake and the underside of the bridge deck.

Today, Enbridge’s existing dual Line 5 pipelines are located within a lakebed utilities area west of Mackinac Bridge. This area also includes power cables and dual gas lines owned and operated by other companies. Above the Line 5 pipelines, the maximum width of the channel is approximately 700 feet for the east pipeline and 800 feet for the west pipeline (Figure 24).

Figure 22: A U.S. Coast Guard vessel travels in the shipping channel between the piers and towers of the Mackinac Bridge.





Figure 23: This shipping-traffic-density map shows how the traffic converges at it approaches the Mackinac Bridge.

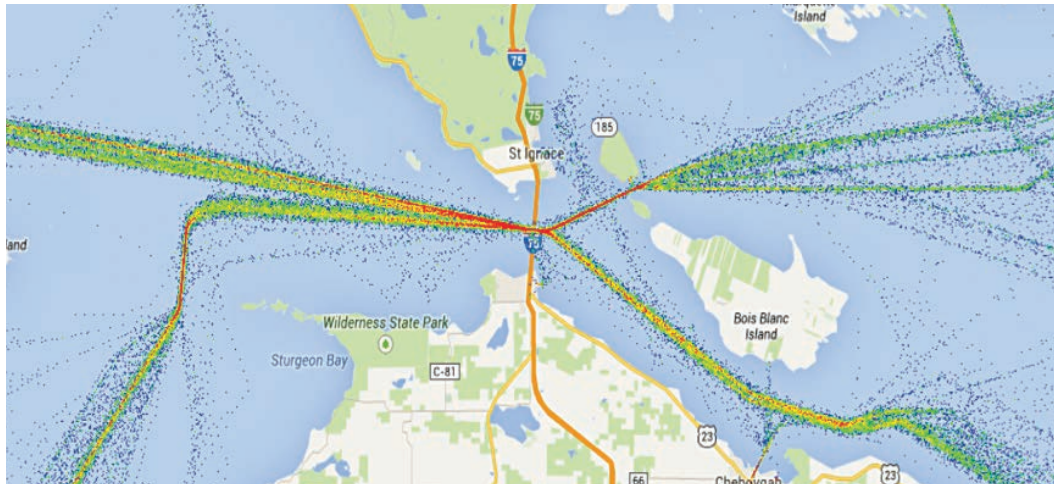
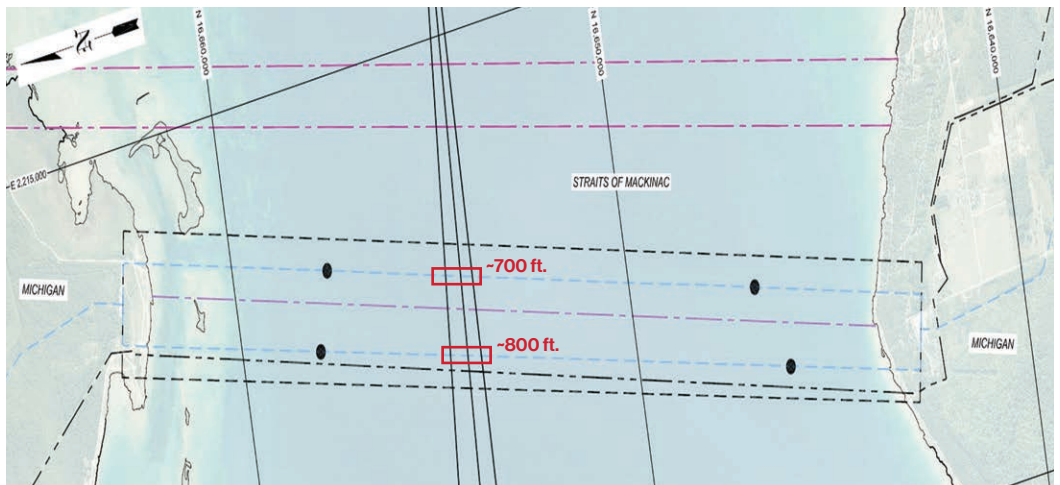

Figure 24: The Straits shipping channel/lanes and, in red, the width of the channel over the existing dual Line 5 pipelines.



## Anchor drop and drag protection

To protect the section of the pipeline on the lakebed against damage from anchor strikes or other dropped objects, it would be covered—starting at a water depth of 30 feet on both shores—with an engineered protective cover made of gravel and cobble.

The sections from 30 feet water depth to the shore would be trenched to nine feet and then the pipeline would be installed in the trench and buried.

To illustrate this, INTECSEA divided the pipelines into three zones, as follows (Figure 25):

- **From the shore to a water depth of 30 feet:** Trenched and several feet of natural cover over the pipeline (Zone A).
- **From water depth of 30 feet to the start of the shipping channel:** Trenched and transitioned from natural cover to engineered protective cover (gravel and cobble) over the pipeline (Zone C).
- **The shipping channel:** Pipeline on the lakebed (Figure 26) and covered with engineered protective cover (gravel and cobble) to protect the pipeline from an accidental ship anchor drop and drag (Zone B).

Figure 25: Pipeline cover zones; shown with 25 times vertical exaggeration.

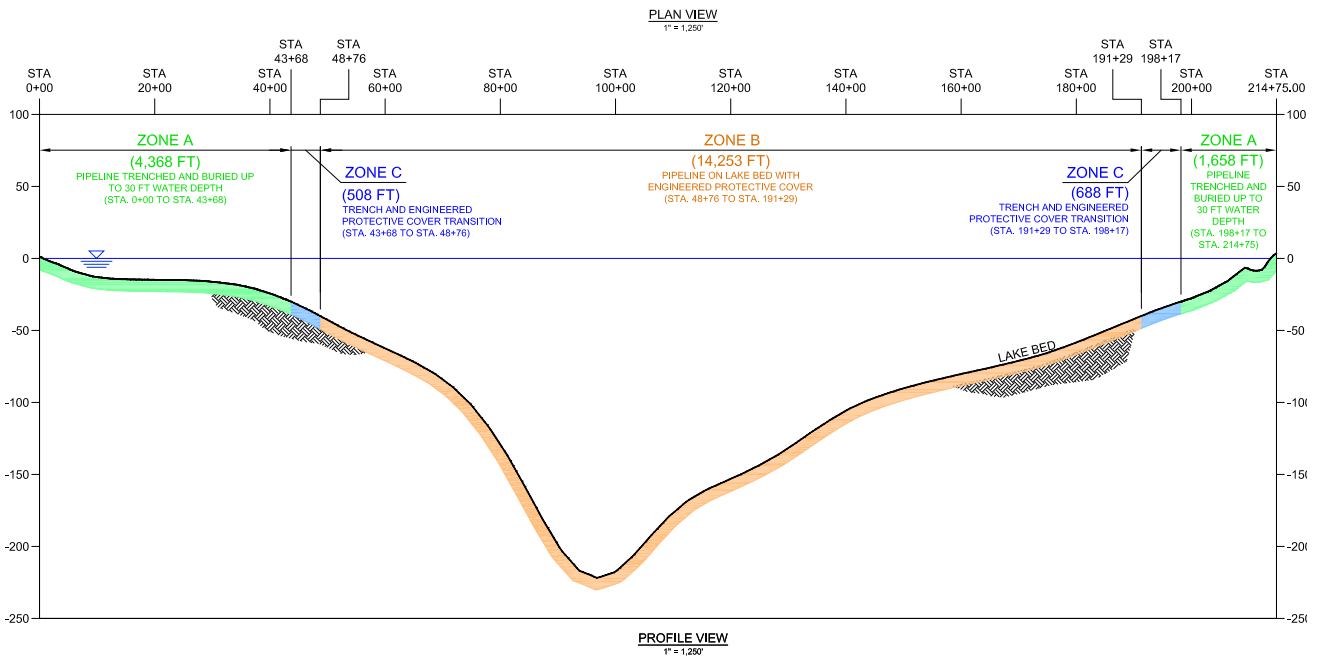
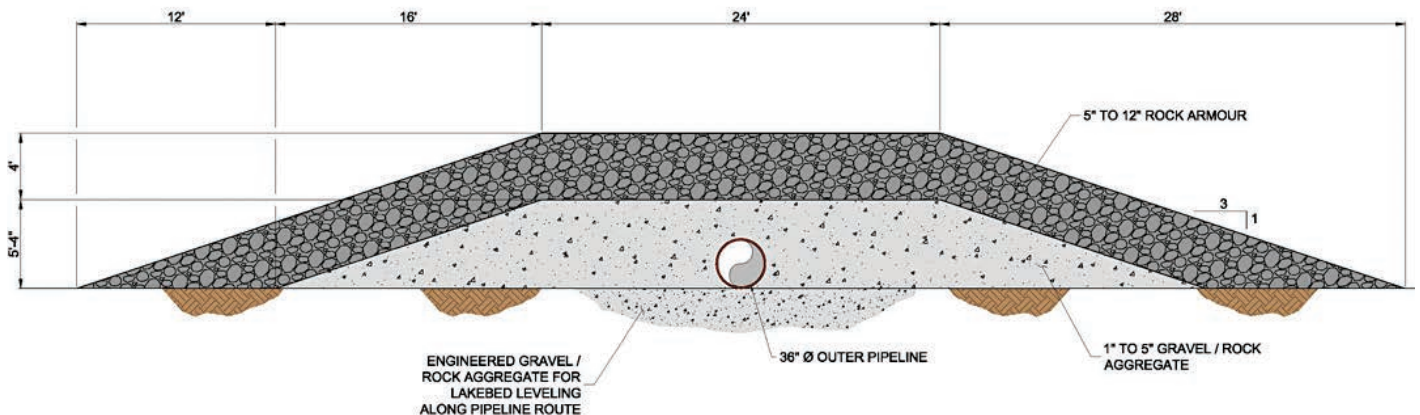

Figure 26: Pipeline covered with engineered protective cover across the lakebed—Zones B and C.



INTECSEA proposes the engineered protective cover be six- to eight-feet thick from the top of the pipe so that an anchor drop directly over the pipeline would not put the integrity of the pipeline at risk. With the proposed depth of cover, no contact with the pipeline is anticipated for even the largest expected anchor size of 10.2 metric tons (Figures 27, 28 and 29).

Figure 27: An anchor drops over the pipeline and drags away from the pipeline.

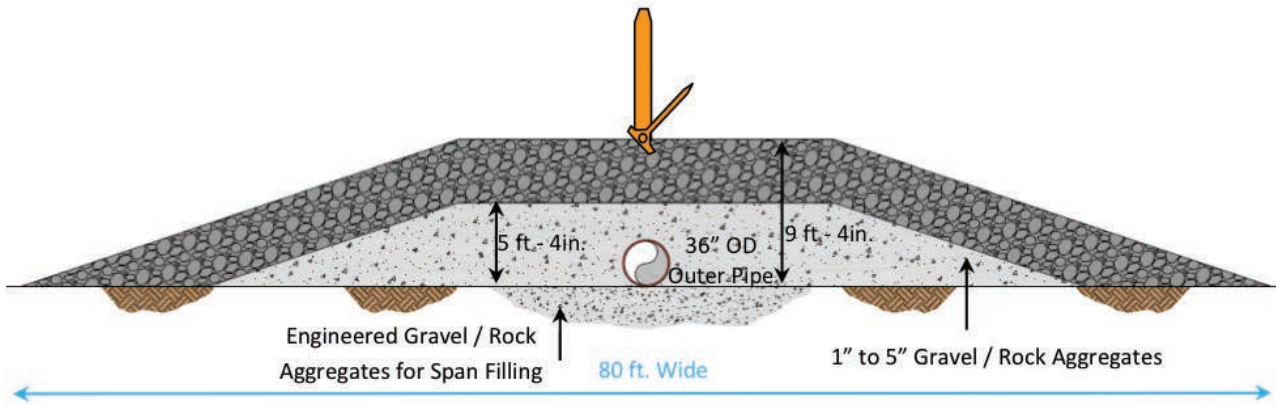

Figure 28: An anchor drops away from the engineered protective cover and drags.

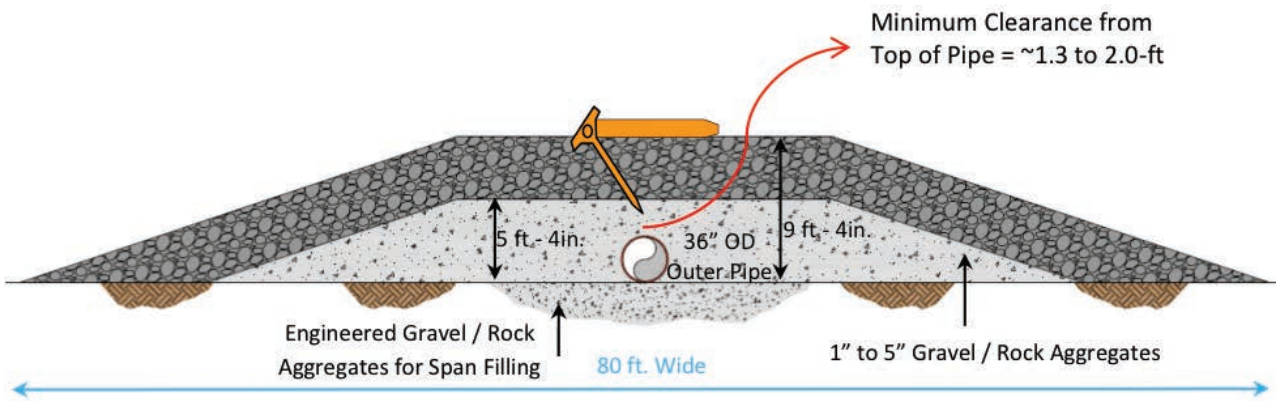
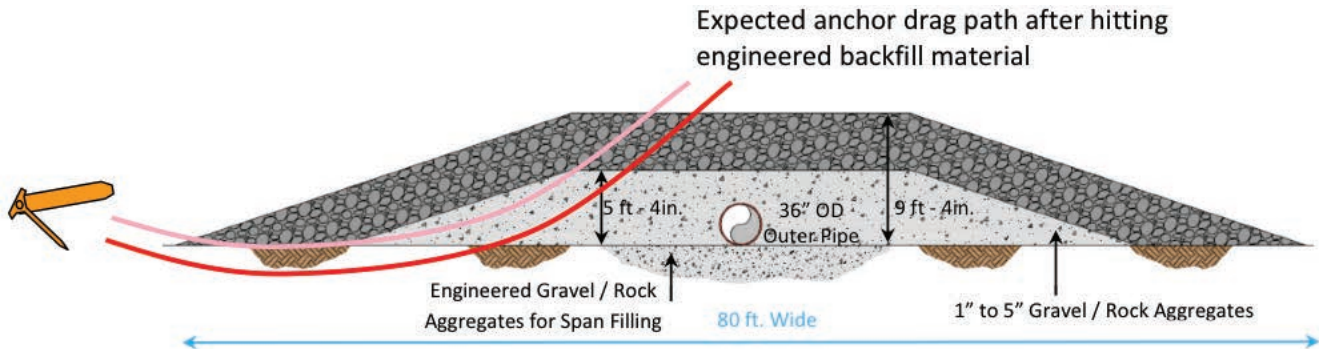

Figure 29: Path of anchor through the engineered protective cover.





**What is deadweight tonnage?**

Deadweight tonnage is a measure of the total amount of weight a ship can carry. In other words, DWT is the sum of the weights of cargo, fuel, fresh water, ballast water, provisions, passengers and crew.

**What is a fluke?**

A fluke is the pointed projection on an anchor that digs into the lakebed.

**What is a drag-embedment anchor?**

A drag-embedment anchor is pulled—in other words, dragged—into a lakebed or seabed. They are the most common type of anchors used in the Great Lakes.

**Anchor size considerations**

To analyze the potential impact of an anchor drop and drag on the proposed engineered protective cover, INTECSEA assessed anchor weights and types that would be used by the largest cargo vessels traveling through the Straits.

The largest cargo vessels are Great Lakes freighters, which were constructed in the region and are too large to move through the locks of the St. Lawrence Seaway. Data available from the public domain have shown that the largest of these vessels has a capacity of approximately 92,000 deadweight tonnage (DWT) and the longest vessel is approximately 1,000 feet. These freighters would carry the largest anchors of any vessel travelling through the Straits.

The second largest vessels on the Great Lakes are classed as ‘Seawaymax’, which can move through the St. Lawrence Seaway locks. The maximum size of a Seawaymax vessel is 740 feet long, 78 feet wide, 116 feet in height with a 26-foot draft. A standard Seawaymax-class vessel has a capacity of 28,500 DWT, while a Seawaymax-class oil tanker has a maximum capacity of 60,000 DWT.

For its anchor drop and drag assessment, INTECSEA based its calculations for the design of the engineered protective cover on the anchor type, weight and fluke length used by the largest Lake freighters as detailed in the table below.

*Vessel and Anchor Data*

Parameter	Value
Vessel length	1,013 feet (308.8 meters)
Vessel width	105 feet (32 meters)
Vessel depth	56 feet (17.1 meters)
Estimated anchor weight <sup>1</sup>	22.5 kips <sup>2</sup> (10.205 metric tons)
Projected anchor fluke length	4.3 to 5.0 feet (1.3 to 1.4 meters)

<sup>1</sup> Anchor weight estimate is based on “Rules for Building and Classing; Bulk Carriers for Service on the Great Lakes 2017”, American Bureau of Shipping, updated March 2018.

<sup>2</sup> A kip is a U.S. customary unit of force. One kip equals 1,000 pounds-force.

There are a wide variety of drag-embedment anchors used by ships in the Great Lakes. The majority of these anchors are shown in *Figure 30* below. The U.S. Navy Stockless anchor (second from right) is the most common type and INTECSEA used it as the basis for its feasibility study.

*Figure 30: Typical ship drag-embedment anchors.*

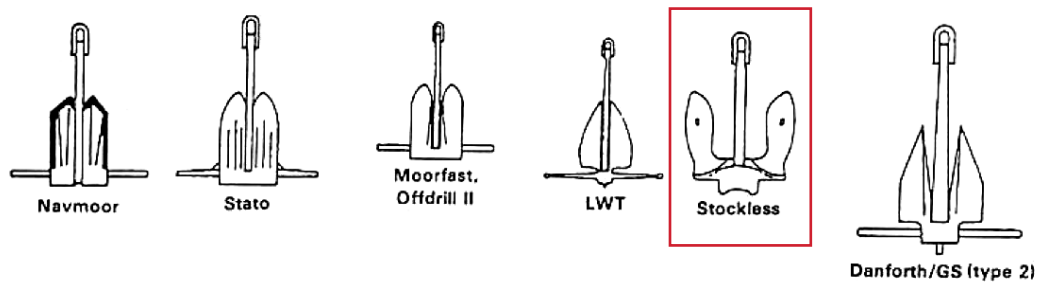

### Placing the engineered protective cover on the pipeline

Most harbors around the world rely on engineered protective covers to protect pipelines and power cables from anchor damage. There is a proven and well-tested technique for placing cobble onto a pipeline without causing damage—using a vessel outfitted with a side-fall pipe that can be directed and monitored by either onboard cameras or remotely operated vehicle (ROV).

This ensures the rock is placed at the intended location on top of the pipe (Figure 31). Existing vessels, such as hopper barges or flat top barges, can be outfitted with a fall-pipe system that includes a loading conveyor and portable crane or small bulldozer for loading the side-fall pipe with engineered protective cover.

For the Straits pipeline, this would be the likely method used to provide the most accurate placement of the engineered protective cover.

*Figure 31: This purpose-built rock placement vessel deploys stone through a side-fall pipe at a controlled rate, while the vessel moves along the pipeline route forming a stone berm to protect the pipeline. The end of the side-fall pipe is controlled from the surface. To provide precision rock placement, the operator uses visual and sonar confirmation of the fall-pipe location relative to the pipeline to be covered.*

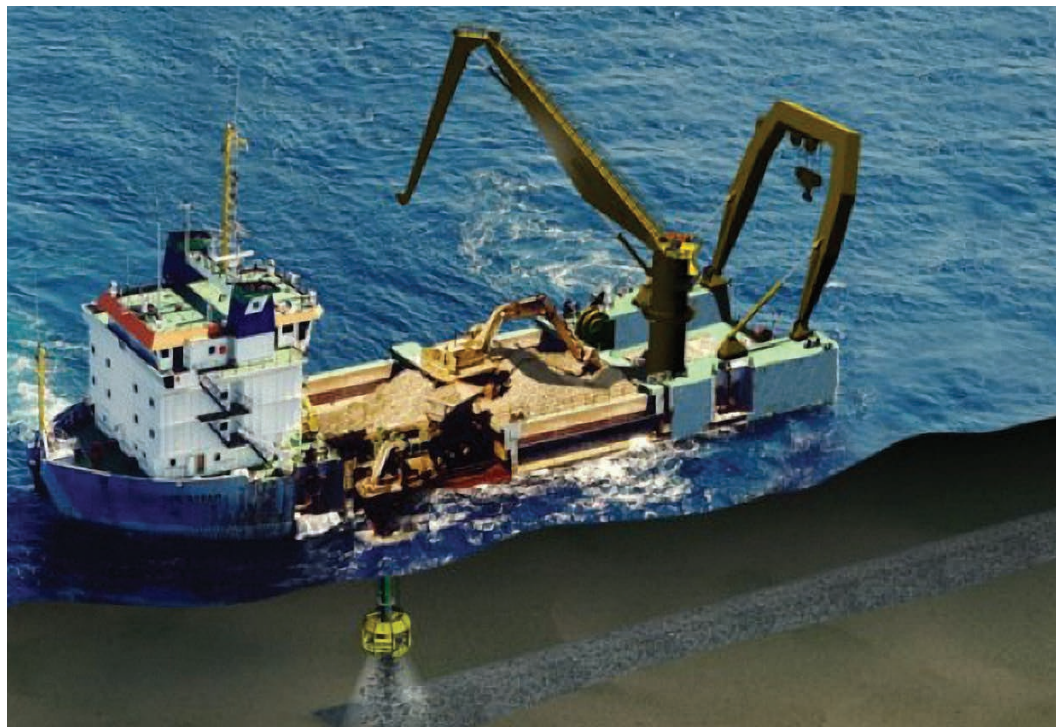

## Corrosion protection

INTECSEA states that in a pipe-in-pipe system, it is an acceptable design practice to protect the inner pipe with a primary corrosion protection coating and the outer pipe with cathodic protection. Several such installations are in operation worldwide.

For the Straits pipeline, INTECSEA proposes that the exterior of the 30-inch inner product pipe would feature a fusion-bonded epoxy (FBE) anti-corrosion coating (Figure 32). The 36-inch outer secondary-containment pipe would be in contact with the soil and lake water, so it would be coated with a three-layer polypropylene (3LPP) anti-corrosion coating system (Figure 33). The 3LPP system would also add an additional layer of protection against abrasion during installation.

In addition to primary anti-corrosion coatings, the outer pipeline would also have a cathodic protection (CP) system utilizing “impressed current”.

If the open cut with secondary containment alternative moves forward, corrosion protection design would be further evaluated during the front-end engineering design (FEED) phase of the project.

### What is an impressed current system?

Hydrocarbon pipelines are routinely protected by a coating supplemented with cathodic protection. An impressed current cathodic protection system (ICCP) for a pipeline consists of a DC power source, often an AC powered transformer rectifier, and an anode or array of anodes.

The proposed impressed current system has been operating successfully on existing pipelines for more than 65 years.

Figure 32: Proposed primary FBE anti-corrosion coating for the 30-inch product-carrying inner pipeline.

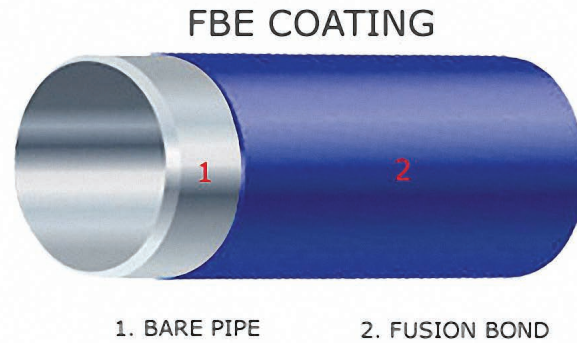
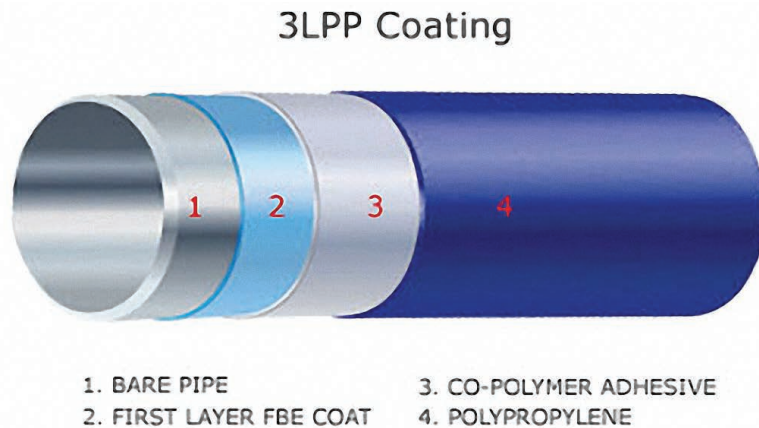

Figure 33: Proposed primary 3LPP anti-corrosion coating for the 36-inch secondary-containment outer pipeline.





## Shore approaches and burial design

INTECSEA has assumed an optimized trench depth of nine feet for the shoreline pipeline out to a water depth of 30 feet. This would provide six feet of cover over the pipeline and provide burial of the pipeline.

The same method would be used for construction of both the north and south shorelines.

Onshore, a back-hoe would create a nine-foot-deep trench with a 10-foot-wide bottom as far as necessary to transition from ground level to a nine-foot trench bottom. Near the end of the onshore trench, the trench would taper to the onshore trench level.

Based on preliminary engineering for an open cut trench, the shoreline dimensions would be approximately (Figure 34):

- Trench width at bottom: 10 feet.
- Trench depth from shore to 30-foot water depth: 9 feet.
- Trench side slope angle: 1:3.
- Trench top opening: 64 feet.

Figure 34: Trench profile—shorelines to 30-foot water depth.

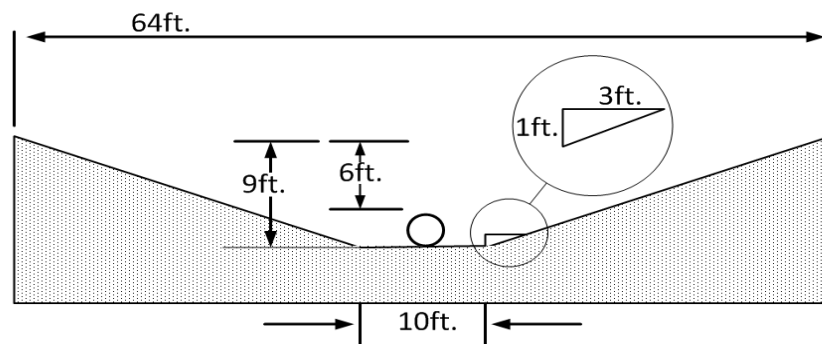

A backhoe dredger barge—a hydraulic backhoe arm mounted on a shallow draft barge—would be used from the shoreline to 30-foot water depth (Figure 35). Backhoe dredgers are extremely accurate when equipped with onboard survey systems that can pinpoint the location of the dredge bucket within one foot. The barge is suitable for work in confined spaces and where known hazards, such as pipelines or power cables, are located.

Figure 35: Typical backhoe dredger (left) and onboard dredging survey system (right).

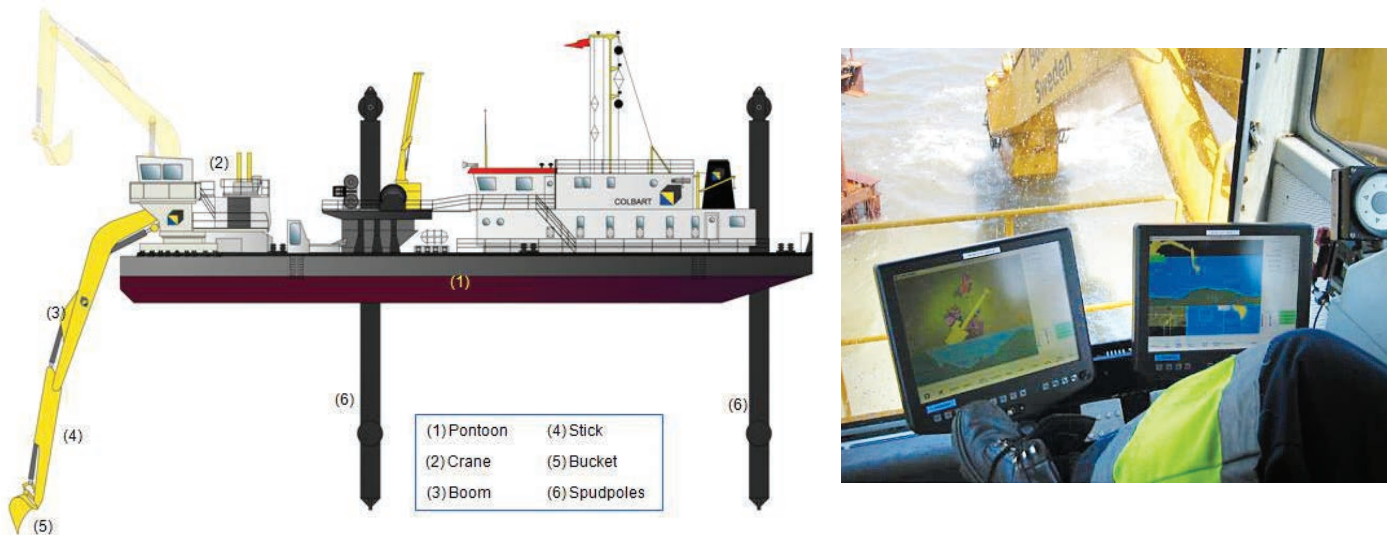

Between the north and south trench, the pipeline would run along the lakebed. This section would be covered with cobble, as detailed in the *Placing the engineered protective cover on the pipeline* section above.

### Onshore worksites

For each end of the proposed new pipeline, temporary work sites would be required. The north-shore worksite would be set up for pipeline fabrication and feeding of the new pipeline across the Straits to the south worksite. The south-shore worksite would be set up to accommodate a pulling system to bring the fabricated pipeline across the Straits.

### Geological considerations

According to *Geology of Mackinac Straits in Relation to Mackinac Bridge* by Wilton N. Melhorn (1959), the surficial geology includes lacustrine silt and clay, glacial till, outwash deposits (sand and boulders) and sandy clay (possibly till).

However, there were no detailed site-specific geotechnical data available for the project location when INTECSEA was conducting its feasibility study.

Since lakebed geotechnical data is critical to the trenching assessment and to anchor drop and drag analyses, collection of project/site-specific geotechnical data at the crossing location would be imperative should the open cut alternative be pursued.

---

## Independent Assessment of INTECSEA’s ‘Open Cut with Secondary Containment’ Feasibility Study

### Independent Consultant’s Conclusions

Project Consulting Services, Inc., a leader in the pipeline construction industry and the Independent Consultant assessing INTECSEA’s feasibility study, stated the following:

*“The pipeline design is robust as it exceeds regulatory criteria, as well as offshore standards. Also, with today’s improved manufacturing, metallurgy, testing, and assessment tools and standards, the design would result in significantly lowered pipeline risks both during installation and operation.”*

### Constructibility Reviewers’ Opinion

In their joint opinion letter, the Constructibility Reviewers of INTECSEA’s report on the feasibility of the open cut alternative—Michael Baker International, a leading provider of engineering and consulting services; and Kokosing Industrial’s Durocher Marine Division, which provides construction services for activities above or below water—stated:

*“The general approach presented in the report for the installation of a pipe-in-pipe (30-inch crude oil transmission line inside a 36-inch casing) is constructible and reflects use of design and construction techniques successfully used during the 1953 installation of the existing twin 20-inch pipelines as well as technological changes and advances to design and construction techniques available now.”*

---

## Construction Cost Estimate

Estimated capital cost:  
US\$250 – 300 million

The estimated capital cost for open cut with secondary containment option—using a pipe-in-pipe system—is US\$250 – 300 million. This total installed cost includes installing the pipe-in-pipe system, tie-ins to the existing 30-inch pipeline, property acquisition that may be required and internal costs.

---

## Construction Schedule

Estimated total project execution: 4 to 5 years

The estimated time to secure all approvals (a description of the permits required can be found in the Permits and Approvals section below), procure materials and construct the pipeline is about four years. This includes completing all environmental surveys, the offshore geotechnical bore program, preparing applications and completing detailed design. The schedule could stretch to five years due to seasonality restrictions and challenges.

Please see *Appendix 4* for a high-level schedule.

---

## Open Cut Permits and Approvals

We assume it will take more than two years to secure all the permits and authorizations to build a pipeline using the open cut method.

The open cut would require at least 15 state and federal permits; the same permits required for the tunnel. As with the tunnel, the primary regulators would be the U.S. Army Corps of Engineers, Michigan Department of Environmental Quality, Michigan Department of Natural Resources and Michigan Public Service Commission.

The permits and approvals that would be required address the following features and issues:

- Geotechnical investigations
- Wetlands
- Great Lakes and Connecting Waters Intermittent Stream
- Environmental Areas—public, state or federal
- Protected Species
- Cultural Resources
- Soil Erosion
- Special Use Permit
- Noise and Lighting
- Stormwater Discharge
- Hydrostatic Pressure Test
- Great Lakes Shipping Channel—Marine Traffic
- Certificate of Public Convenience and Necessity

Several local permits would also be required—such as zoning, building, special use, etc.—from Moran Township, City of St. Ignace, Emmet County and Mackinaw City.

While the number and type of permits and approvals for the open cut appears to be identical to those required for the tunnel, it should be noted that the scope of the open cut would likely be considered by regulators to have the potential for impacts that may not fit the definition of minimal individual and cumulative adverse environmental effects. This means an Individual Permit likely would be required and that could prolong the permitting process.

Should this alternative move forward, Enbridge would consult with the appropriate agencies on the proposed design and scope of work. Specific permitting durations would be determined and confirmed after consultation with agencies.

A list of the most likely permits and approvals is included in *Appendix 5*.

---

## Open Cut with Secondary Containment Risk Assessment

Should the open cut alternative move forward, a detailed risk assessment would be developed. This would consist of risk workshops to facilitate updates to the risk assessment, including:

- Identifying potential risk events that could affect project outcomes.
- Assigning probability of occurrence to each risk event.
- Assigning severity of occurrence to each risk event, should it occur.
- Developing risk response strategies to control or mitigate adverse impacts.
- Identifying risk events that require further analysis.
- Assigning ownership of risks and defining how they will be managed.
- Tracking all open actions until they are closed.

As part of this feasibility study, a high-level risk assessment was developed and the following risks were identified:

- **Geologic route selection – topography of lakebed; boulders; obstacles:** As the line will be pulled from one shore to the other, the pipeline route must be a straight line and the lake bottom contours will have an impact on the costs and routing of the pipeline. Lakebed depressions below the pipe that create unsupported spans will need to be backfilled to provide adequate support and prevent under-pipe erosion of the lakebed. The ideal shore-to-shore linear connection may not align with the ideal shore-approach points, so a compromise between best shore points and best lake route may be required.
- **Shore approach stability and excavation to water depth transition point**—Cofferdams reduce the width of the trench, thereby reducing dredging quantity and environmental footprint. The piling required could have installation obstacles due to shore geology and rock formations. Excavation methods and dredging may add unknown complexities in permitting and design.
- **Extreme weather conditions** may delay or affect the construction timelines.
- **Delays in receiving permits** may affect construction timelines because the schedule is sensitive to seasonal restrictions—icing of the Straits, fish spawning, shoreline nesting birds, etc.—that limit the construction window to April – October.

# Alternative: Horizontal Directional Drilling

Not Feasible

After careful study by the Lead Engineering Consultant for this alternative, and in consultation with Enbridge and other experts involved, the alternative to use the HDD construction method for the full length of the Straits of Mackinac crossing was deemed to be not feasible and was withdrawn from consideration.

## Overview of the HDD Construction Method

Horizontal directional drilling (HDD) is a proven technique for constructing pipelines under lakes, rivers and streams, as well as obstacles such as highways and railroads. Enbridge uses the HDD method to minimize impacts on the area above the drill hole.

The HDD process uses advanced technology to drill an underground arc from an entry point, down and then under a waterway or other designated area, and then up to resurface on the opposite side. A pipe is then installed by pulling it through the drilled hole.

The HDD process begins by establishing work space or staging areas at both sides of the horizontal directional drill—the entry and exit points. On the entry side, the HDD drill rig, drilling fluid pumping and cleaning system, and other ancillary equipment are set up. On the exit side, welded pipeline segments are pre-assembled.

Installation of a pipeline by HDD is generally accomplished in three phases, as illustrated in *Figure 36*. The first phase consists of directionally drilling a small diameter pilot hole along a designed directional path. The second phase—called prereaming—involves enlarging the pilot hole to a diameter that will accommodate the pipe to be installed. The final phase—called pullback—consists of pulling the pipe through the enlarged hole.

Drilling fluid is used in all phases and serves a critical function in the HDD process. The fluid is a watery mud-slurry mixture, typically composed of about 95 percent water and 5 percent bentonite clay—a natural, non-toxic substance. Drilling fluid coats the wall of the drill hole for more efficient cutting, stabilization of the hole, and serves as a transport medium for removal of rock and soil cuttings. This drilling fluid is pumped into the drill hole under pressure from the surface.

Three primary parameters govern the technical feasibility of an HDD installation: 1) drill length; 2) pipe diameter; and 3) subsurface material (the rocks and soil). These three parameters work in combination to determine what can be achieved using existing HDD tools and techniques. However, technical feasibility is primarily determined and limited by the nature of the subsurface material. The problematic subsurface condition most often encountered in evaluating the feasibility of an HDD installation is coarse material such as gravel, cobble and boulders.

Figure 36: The three phases of the HDD construction method.

**PILOT HOLE**

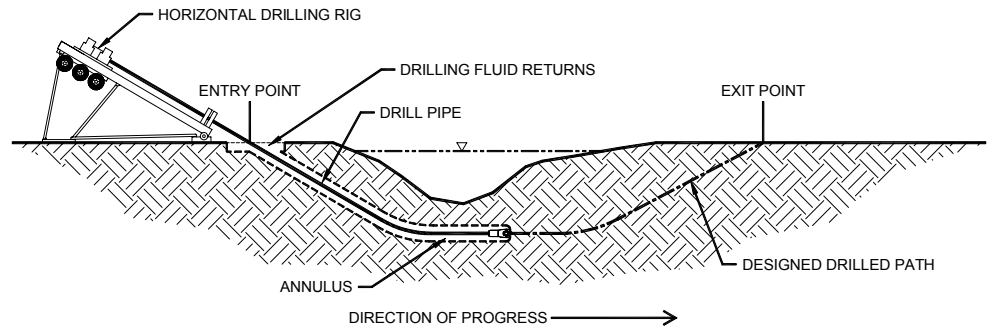

**PREREAMING**

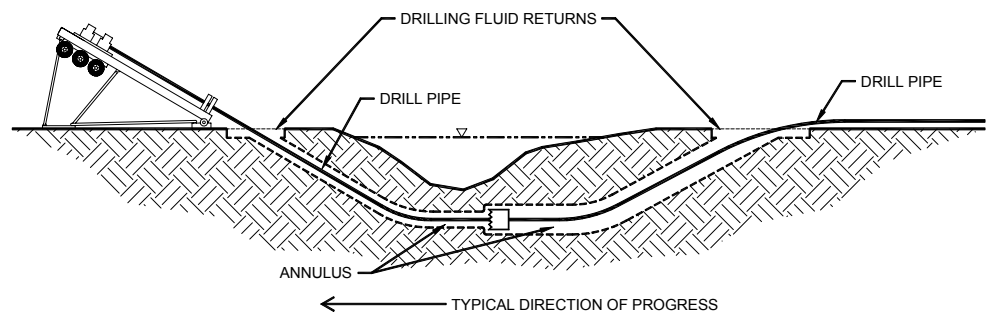

**PULLBACK**

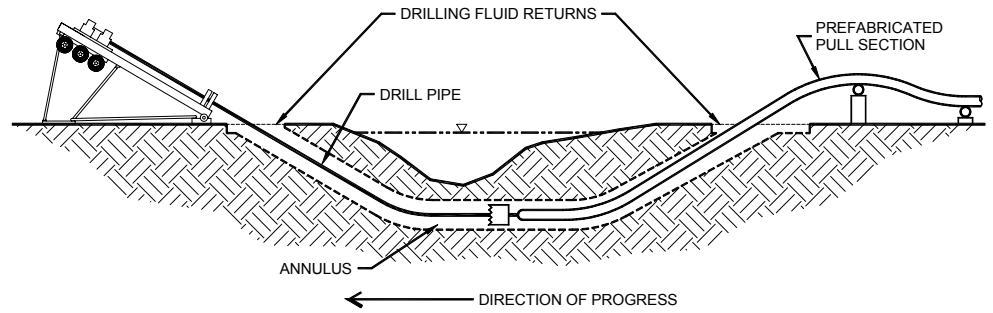



---

## Summary of Results of the HDD Feasibility Study

### HDD consultants

Enbridge engaged the following consultants to thoroughly study the feasibility of using the HDD construction method to install a new 30-inch pipeline beneath the Straits of Mackinac as a replacement for the existing dual Line 5 pipelines:

- **Lead Engineering Consultant:** J. D. Hair & Associates (JDH&A), an industry leader in the design of HDD pipeline crossings. Since its founding in 1987, JDH&A has consulted on more than 1,000 HDD crossings in locations ranging from Alaska to Australia.
- **Independent Consultant:** GeoEngineers, an earth science and technology firm that has completed hundreds of HDD pipeline crossings around the world; and ADIT Engineering, which provides front-end engineering and design, detailed design, and construction support for trenchless crossings, including HDD.
- **Constructibility Reviewer:** Michels Corporation, a North American leader in HDD that has successfully completed HDD crossings in all 50 states, and internationally.

### Objectives of the HDD feasibility study

JDH&A set two objectives for its HDD feasibility evaluation:

- develop conceptual HDD installation options; and
- assess the feasibility of those conceptual options.

In performing its evaluation, JDH&A relied on the following subsurface information:

- A cross-section of the Straits with the existing grade, water surface elevation, and anticipated top of bedrock taken from a geotechnical borehole plan produced by Hatch, the lead consultant for the tunnel alternative, titled “Straits of Mackinac Crossing—Proposed Boreholes for Geological/Geotechnical Investigation”. This cross-section served as the basis for JDH&A’s conceptual designs because site-specific lakebed topography and geotechnical information has not been obtained.
- General geologic information relative to the Straits of Mackinac taken from available drawings and geologic summaries associated with construction of the Mackinac Bridge.

## HDD options and concerns

JDH&A evaluated three HDD options and identified several fundamental concerns that put into the question the technical feasibility of using the HDD construction method for crossing the Straits of Mackinac. Their primary concern is the nearly four-mile length of the crossing.

In light of these concerns, JDH&A determined that the three HDD options are not technically feasible.

The following table describes each option, as well as JDH&A's opinion on the feasibility:

	Description	Feasibility
<b>Option 1</b>	A single shore-to-shore HDD installation with a length of approximately 20,000 feet. All HDD operations would be conducted from onshore locations situated on either side of the Straits.	<b>Not technically feasible</b> due to the 20,000-foot length, which is more than double any comparable crossing that has been completed to date and is beyond the current technical capabilities of the HDD industry.
<b>Option 2</b>	Two shore-to-water HDD installations with a common endpoint near the middle of the Straits. One HDD installation would be approximately 9,300 feet in length and the other would be approximately 11,000 feet in length. A marine platform to support an offshore HDD rig would be required at the common end point in the middle of the Straits.	<b>Not technically feasible</b> due to the need to place the marine platform in the middle of the Straits' active shipping channel, as well as a challenging combination of length, diameter and subsurface conditions.
<b>Option 3</b>	Three HDD installations (two shore-to-water and one water-to-water) with lengths ranging from approximately 5,000 to 8,500 feet. Two marine platforms located on either side of the active shipping channel would be required to support an offshore HDD rig.	<b>Not technically feasible</b> , especially if the work must be completed in a single season that will be shortened by ice formation and fisheries blackout periods in the Straits. Installation of the support structures and casings that would be required to contain drilling fluid may be problematic considering the water depths and strong currents. Handling of the long pipe string in the water-to-water section also becomes unwieldy due to the long length and required marine infrastructure.

### Independent Assessment of JDH&A's HDD Feasibility Study

In their joint HDD feasibility review, the Independent Consultants—GeoEngineers and ADIT Engineering—concurred with JDH&A that options 1, 2 and 3 are not technically feasible.

GeoEngineers and ADIT Engineering said:

*"During the course of our evaluation we identified additional feasibility concerns relative to Options 1, 2 and 3. We concur with the Lead Consultant's position that Options 1, 2 and 3 are not feasible given the current state of the art within the HDD industry."*

### Conclusion Regarding the Feasibility of the HDD Alternative

JDH&A presented its findings to Enbridge and the State of Michigan's representatives in March 2018. After discussion, the parties agreed that the alternative to use the HDD construction method for the full length of the Straits of Mackinac crossing should be withdrawn from consideration because all options considered are not feasible.

# Environmental Impacts of the Two Feasible Alternatives

Simultaneous to the Lead Engineering Consultants conducting their feasibility studies, Stantec, the Lead Environmental Consultant, conducted a detailed environmental impact analysis for the alternatives.

Until more detailed engineering and design work is completed, it is not possible to determine the precise alignment and location of the tunnel or the open cut pipeline, which creates challenges in identifying the potential environmental impacts.

To overcome this challenge, Stantec first defined boundaries for three areas of interest (AOI)—north shore, south shore and open water. The boundaries were drawn large enough to provide flexibility in determining the precise location of the tunnel or open cut facilities, while still allowing a reasonable and comprehensive assessment of the potential environmental impacts to be identified.

The AOIs do not represent the actual construction and operational footprints of each alternative; they represent a large area in which the work will likely take place. The three AOIs are:

- 1. North shore AOI:** is located west of St. Ignace and is roughly centered on Enbridge's existing North Straits Station. The AOI is approximately 300 acres in size.
  - The tunnel would ultimately require approximately 10 to 15 acres of workspace during construction; and about one acre of permanent operational footprint.
  - The open cut would require about six to eight acres of workspace; no new significant above-ground permanent facilities anticipated.
- 2. Open water AOI:** is located in the Straits and connects the shoreline portions of the south and north shore AOIs. The open water AOI is approximately 1,400 acres in size and approximately four miles long.
  - The tunnel would have no impact on this AOI during construction or operation.
  - The open cut would install the pipeline into a trench created using standard offshore dredging techniques on both the north and south shorelines up to 30 feet of water depth, approximately one-half mile offshore. In water depths greater than 30 feet, the pipeline would lie on the lake bottom and be covered with engineered protective cover. From the top of the pipe, the protective cover would be six- to eight-feet thick.
  - The geotechnical bore program required for both alternatives could disrupt recreational boaters or sport fishermen within this AOI. This impact would be short in duration.
- 3. South shore AOI:** is located west of Mackinaw City and is roughly centered on the existing Enbridge Mackinaw Station. The AOI is approximately 600 acres in size.
  - The tunnel would require approximately two to eight acres for workspace at the south shore; and about one acre of permanent operational footprint.
  - Open cut would require approximately one to two acres of workspace; there are no new significant above-ground permanent facilities anticipated.

Please see *Appendix 6* for an image of the AOI demarcation.

The potential environmental impacts and potential mitigation measures identified by Stantec are described in the following table.

## Potential Environmental Impacts—Applicable to Both the Tunnel and Open Cut Alternatives

Potentially Affected Environment	Potential Construction, Operation/Maintenance Impact	Potential Mitigation Measures
<b>Air Quality—All AOIs</b>	<b>Construction and Operation</b> Air emissions from diesel engines and new engines	<ul style="list-style-type: none"> <li>Use ultra-low-sulfur diesel for all diesel engines operating throughout the project sites. Proper maintenance of construction equipment and use of ultra-low-sulfur diesel fuel would minimize engine emissions during Project construction.</li> <li>Give preference when possible to newer (post-2010) diesel engine-powered marine vessels and diesel-powered non-road construction equipment; specify all diesel-powered engines used in construction with a power rating of 50 hp or greater should meet at least the Tier 3 emissions standard. Those rated less than 50 hp should meet at least the Tier 2 emissions standard.</li> </ul>
	Air emissions from all equipment	<ul style="list-style-type: none"> <li>Specify that on-site vehicle idle time while in the construction area be restricted for all equipment and vehicles that are not using their engines to operate a loading, unloading, or processing device.</li> </ul>
	Airborne dust associated with construction traffic and activities	<ul style="list-style-type: none"> <li>Develop a Fugitive Dust Control Plan to be implemented during the construction activities.</li> <li>Project contractors could be required to have all trucks hauling loose material be equipped with tight-fitting tailgates and their loads securely covered prior to leaving the Project construction sites; and water sprays could be used for excavation and transfer of soils to ensure that materials would be dampened as necessary.</li> </ul>
<b>Aquatic Organisms and Their Habitat—Open Water AOI</b>	<b>Construction—Geotechnical Investigation</b> Increased runoff and turbidity, altering behavior of fish and benthic organisms (those that live in and on bottom of lake floor) during geotechnical drilling programs	<ul style="list-style-type: none"> <li>Survey benthic habitat below drilling rigs to determine if unique habitat or species are in the area.</li> <li>Conduct surveys of the shallows for sensitive fish habitat.</li> <li>Operate open water drilling during daylight hours, if possible. Use minimal amount of lighting in near shore areas—as required for nighttime construction activities, lighting could be directed toward the center of the construction site and shielded to prevent light from straying, or spilling, offsite. Hooded, task-specific lighting could be used to reduce light trespass.</li> <li>Considering using noise-reducing methods.</li> </ul>
	Exposure to potential toxins/contaminants (for example fuel, grease, hydraulic fluid, etc.) from: <ul style="list-style-type: none"> <li>Worksite spills</li> <li>Accidental discharge of a detention pond</li> <li>Thermal effects of dewatering during summer months</li> </ul>	<ul style="list-style-type: none"> <li>Restrict fueling locations, multiple forms of containment for contaminants and drilling waste storage, implement erosion control on disturbed land, monitor rain events and have a spill prevention control and countermeasure (SPCC) plan in place.</li> <li>Before dewatering activities, the water should be tested to minimize impacts to aquatic species.</li> </ul>
	Small aquatic organisms pulled into the water intake hose and through the pump or become impinged on a filter during hydrostatic testing	<ul style="list-style-type: none"> <li>Locate intake hose away from aquatic organism dense habitats such as shallow near shore areas</li> </ul>

Potentially Affected Environment	Potential Construction, Operation/Maintenance Impact	Potential Mitigation Measures
<b>Water Resources— North and South Shore AOIs</b>	<b>Construction</b> <ul style="list-style-type: none"> <li>Contamination from worksite spills to surface and groundwater</li> <li>Increased stormwater runoff and turbidity</li> </ul>	<ul style="list-style-type: none"> <li>Restrict fueling locations, multiple forms of containment for contaminants and drilling waste storage, implement erosion control on disturbed land, monitor rain events and have a spill prevention control and countermeasure (SPCC) plan in place.</li> <li>A site-specific stormwater pollution prevention plan (SWPPP) would be developed.</li> </ul>
	Exposure to potential detained stormwater	<ul style="list-style-type: none"> <li>Construct water detention pond a sufficient distance from surface waters, ensure it has the correct capacity and proper construction to limit seepage or an accidental spill.</li> </ul>
<b>Archaeological Resources— North and South Shore AOIs</b>	<b>Construction</b> Disturbance of Archaeological Sites	<ul style="list-style-type: none"> <li>Conduct Phase I surveys on areas with proposed ground disturbance and develop mitigation plans for any identified potentially eligible sites.</li> <li>Avoidance— Cultural resources impacts may be avoided through workspace/construction area siting.</li> <li>Data Recovery of Impacted Sites— If avoidance of significant cultural resources is not practical, data recovery could be implemented to mitigate affected resources.</li> </ul>
<b>Historic Resources— North and South Shore AOIs</b>	<b>Construction</b> Adverse visual impacts caused by presence of work spaces	<ul style="list-style-type: none"> <li>Screening: If adverse visual effects to historic or cultural resources are identified screening, typically utilizing plants, shrubs, or trees, complementary to the existing landscape could minimize the visual impact to the resource.</li> <li>Feathering along the workspace margin would also reduce long-term visual effects.</li> </ul>
<b>Cultural Resources— Open Water AOI</b>	<b>Construction</b> Disturbance of submerged resources	<ul style="list-style-type: none"> <li>Investigate potential disturbances to submerged sites in advance; data recovery investigations to document submerged resources before impact if resource avoidance is not practical.</li> </ul>
<b>Traditional Cultural Property (TCP)— All AOIs</b>	<b>Construction</b> <ul style="list-style-type: none"> <li>Adverse visual or direct impacts</li> <li>Clearing activities could impact previously recorded and unrecorded archaeological sites or historic resources</li> </ul>	<ul style="list-style-type: none"> <li>The evaluation of potential effects to TCPs requires coordination and consultation with Native American tribes recognized by the State of Michigan; should be done early in project planning to identify potential resources and evaluate measures to minimize and/or mitigate potential effects.</li> <li>Visual and direct impacts to TCPs may require consideration of alternative mitigation options that should be discussed with the Native American tribes.</li> </ul>
<b>Soils— North and South Shore AOIs</b>	<b>Construction</b> <ul style="list-style-type: none"> <li>Soils erosion and sedimentation</li> <li>Soil compaction and mixing</li> </ul>	<ul style="list-style-type: none"> <li>Obtain necessary soil erosion control permits; utilize soil erosion best management practices, and thoroughly evaluate construction activities and soil erosion control measures in areas with high runoff potential and/or a high erodibility factor. It may be possible to locate certain activities in areas where soils are less susceptible to soil erosion.</li> <li>Soil compaction could be addressed by using low ground pressure equipment or construction matting in soils that are saturated or inherently susceptible to compaction.</li> <li>Soil mixing could be addressed by segregation of topsoil and replacement in reverse order of removal during site restoration.</li> <li>Employ erosion control measures to limit the generation and transport of sediment from the north and south shore work areas.</li> </ul>



Potentially Affected Environment	Potential Construction, Operation/Maintenance Impact	Potential Mitigation Measures
<b>Hazardous Materials/Waste—All AOIs</b>	<b>Construction</b> Releases of Hazardous Materials or Contaminants	<ul style="list-style-type: none"> <li>Employ industry standard best management practices to prevent release of hazardous materials and contaminants through the use of secondary containments and other spill prevention measures.</li> </ul>
	<b>Waste Generation</b>	<ul style="list-style-type: none"> <li>Employ industry and society standard best management practices to reduce the impact of site waste generation through the use of recycling and waste segregation techniques.</li> </ul>
<b>Workspace—North and South Shore AOIs</b>	<b>Construction</b> Loss of evergreen and deciduous forest and/or palustrine forested wetland due to clearing and/or grading	<ul style="list-style-type: none"> <li>Cut trees flush with the ground and do not grind out the stumps to reduce soil disturbance. Use timbermats to limit soil disturbance in wetlands. Where possible use avoidance measures such as off-site staging or previously disturbed sites to reduce impacts to land use and cover type. Site permanent structures adjacent to the existing station.</li> <li>Where possible consider the preservation of certain mature trees or groups of trees within the workspace boundary.</li> </ul>
<b>Workspace—South Shore AOI</b>	<b>Construction</b> Soil compaction, loss of fertility, reduced crop production. Loss of forested habitat. Soil compaction in grasslands	<ul style="list-style-type: none"> <li>Deep tillage of the subsoil to breakup compaction in cultivated land and grasslands. Cut trees flush with the ground and do not grind out the stumps to reduce soil disturbance. Where possible use avoidance measures such as off-site staging or previously disturbed sites to reduce impacts to land use and cover type.</li> </ul>
<b>Park/Preserve/Historic Sites—South Shore AOI</b>	<b>Construction</b> Removal of trees and construction activities could affect the recreational activities and tourism land uses associated with park, preserve, and historic site, if work occurs in any of the following areas—Headlands International Dark Sky Park, Hathaway Family Regina Caeli Nature Preserve, McGulpin Point Lighthouse and Historic Site	<ul style="list-style-type: none"> <li>Install any permanent structures as close to the existing Enbridge Stations as possible/practical.</li> <li>Avoid construction within the park/preserve/historic site to minimize impacts on recreation and tourism.</li> </ul>
<b>Water Use—Open Water AOI</b>	<b>Construction</b> Temporary disruption to recreational boaters, sport fishermen, and potentially commercial shipping, resulting in temporary change in use of the open water AOI from vessel/barge traffic during the geotechnical bore program	<ul style="list-style-type: none"> <li>If feasible, reduce the number of vessels to minimize impacts on commercial shipping, recreation, fishing, and tourism.</li> </ul>
<b>Adjacent Land Impact—North and South Shore AOIs</b>	<b>Construction</b> Widening roads results in loss of habitat—including evergreen forest, palustrine forested, wetland, mixed forest, low intensity developed land on north shore and deciduous forest, cultivated crops, grassland, evergreen forest on south shore	<ul style="list-style-type: none"> <li>Reclaim widened portions of roads after construction if habitat were impacted, restore to previous habitat.</li> </ul>

Potentially Affected Environment	Potential Construction, Operation/Maintenance Impact	Potential Mitigation Measures
<b>Noise— North and South Shore AOIs</b>	<b>Construction</b> Unnecessary equipment noise	<ul style="list-style-type: none"> <li>On-site vehicle idle time while in the construction area would be restricted for all equipment and vehicles that are not using their engines to operate a loading, unloading, or processing device (e.g., concrete mixing trucks) or are otherwise required for the proper operation of the engine. All contractors could be required to utilize sound control devices no less effective than those provided by the manufacturer and maintain equipment in accordance with manufacturer’s recommendations. No equipment would have unmuffled exhausts.</li> </ul>
	<b>Proximity noise</b>	<ul style="list-style-type: none"> <li>Where possible, work should be staged from the north shore AOI due to the increased setback from noise sensitive areas (NSAs). Due to the distance from the AOI and the existence of a deep woods, which would act as a buffer between the work.</li> </ul>
	<b>Excessive noise</b>	<ul style="list-style-type: none"> <li>Develop a Noise Control plan based on the specific equipment used, activity conducted in specific locations, and proximity to NSAs. For example: back-up alarms; flagmen to minimize the time needed to back up vehicles; low noise emissions (e.g. equipment such as generators with noise enclosures); locate stationary equipment such as compressors, generators, and welding machines away from sensitive receptors; position equipment so noise propagates away from the nearest NSAs; and position non-noise generating equipment, such as a Construction Trailer, between the drilling operation and the nearby NSAs where possible to provide shielding; limit heavy-equipment activity adjacent to residences or other sensitive receptors to the shortest possible period required to complete the work activity.</li> </ul>
	<b>Night-time noise</b>	<ul style="list-style-type: none"> <li>Temporarily and safely install and maintain an absorptive noise control barrier in the perimeter of construction sites, around stationary equipment of interest, and/or between tunnel or open cut construction equipment and NSAs when located in close proximity of noise-intensive equipment operating during overnight periods.</li> </ul>
	<b>Engine Driven Equipment</b>	<ul style="list-style-type: none"> <li>Consideration can be made to utilizing electrically driven equipment over the utilization of engine-driven equipment, such as light towers and compressors.</li> </ul>
<b>Terrestrial Ecosystem— North and South Shore AOIs</b>	<b>Construction</b> Rare plant species and/or habitat loss	<ul style="list-style-type: none"> <li>Design workspaces to avoid habitat.</li> <li>Plant species relocation and transplant.</li> </ul>
<b>Avian Species— North and South Shore AOIs</b>	<b>Construction</b> <ul style="list-style-type: none"> <li>Avian species habitat loss and/or reduced fledging success</li> <li>Reduced migration success</li> </ul>	<ul style="list-style-type: none"> <li>Design workspaces to avoid habitat.</li> <li>Time construction outside avian nesting and migration periods.</li> </ul>
<b>Mammals— North and South Shore AOIs</b>	<b>Construction</b> Habitat fragmentation and loss	<ul style="list-style-type: none"> <li>Consider the preservation of certain mature trees or groups of trees within the workspace boundary.</li> <li>Fencing could be used to identify these areas to avoid damaging trees and to avoid compaction of soils. The reduction in the number of trees felled would reduce effects to forested woodlands and wetlands in the north and south shore AOIs. It would also reduce the long-term visual effects created by construction and could help to reduce fragmentation of wildlife habitat. Feathering along the workspace margin would also reduce long-term effects.</li> </ul>

Potentially Affected Environment	Potential Construction, Operation/Maintenance Impact	Potential Mitigation Measures
Avian and Mammals Species—North and South Shore AOIs	<b>Construction—drilling</b> Alteration of behavior due to 24/7 work schedule	<ul style="list-style-type: none"> <li>Reduce 24/7 schedule to allow times of silence and darkness, or minimize lighting and noise.</li> </ul>
Wetlands—North and South Shore AOIs	<b>Construction</b> Impact to wetland flora, fauna	<ul style="list-style-type: none"> <li>Perform wetland delineation surveys, avoid and minimize potential impacts to wetlands.</li> <li>Implement a wetland restoration and/or mitigation plan for unavoidable impacts to wetlands.</li> </ul>
Plant Species—North and South Shore AOIs	<b>Construction</b> Invasive species introduction	<ul style="list-style-type: none"> <li>Implement invasive species control and restoration plan.</li> </ul>
Use and Access to Roads—North and South Shore AOIs	<p><b>Construction</b></p> <p>Heavy truck traffic on roadways; congestion from construction workers arriving and departing AOI during AM and PM peak hours</p> <p>Increased air and noise impacts from heavy truck traffic</p> <p>Occasional heavy truck traffic from maintenance and operation vehicles</p>	<ul style="list-style-type: none"> <li>Prepare truck routing plan which routes trucks away from institutional uses and minimizes impacts to residential areas, where practical. Restrict heavy truck days/hours. Utilize water tank trucks for dust control.</li> <li>Educate workers on preferred routes which minimize peak hour impacts on roadways serving residential and institutional uses; explore off-site parking/shuttle to and from AOI to reduce worker vehicle traffic.</li> <li>Prepare truck routing plan which routes trucks away from institutional uses and minimizes impacts to residential areas, where practical.</li> </ul>
Tourism Use of Roads—North and South Shore AOIs	<b>Construction</b> Potential impacts to tourist traffic	<ul style="list-style-type: none"> <li>Restrict construction traffic during peak tourism events to help reduce impact. Some of these events are: Memorial Weekend Pageant; Troop Mackinaw (multiple occurrences June through September); Antiques on the Bay Auto Show; the annual St. Ignace Car Show; Mackinaw City Fourth of July (Conkling Heritage Park); and Labor Day Bridge Walk.</li> </ul>
Impact to Roads—North and South Shore AOIs	<b>Construction</b> Construction truck traffic degrades road pavement	<ul style="list-style-type: none"> <li>Conduct pre- and post-construction roadway surveys on roads used to by construction trucks. Repair roadway pavement as needed after construction.</li> </ul>
Visual Impacts—All AOIs	<b>Construction</b> Lighting associated with any nighttime construction or operational activities could spill outside of the project site, affecting surrounding areas, particularly the Headlands International Dark Sky Park	<ul style="list-style-type: none"> <li>Lighting required to facilitate nighttime construction activities should be directed toward the center of the construction site and shielded to prevent light from straying, or spilling, offsite. Hooded, task-specific lighting should be used to the extent practical to reduce light trespass beyond the project site during operation.</li> </ul>
Visual Impacts—North and South Shore AOIs	<b>Construction</b> Loss of vegetation and creation of open space	<ul style="list-style-type: none"> <li>Reclamation of disturbed onshore areas, particularly large areas cleared for stringing of pipeline.</li> </ul>
Wetlands—North and South Shore AOIs	<b>Construction</b> Clearing of vegetation, filling of wetlands and other ground disturbance activities could alter hydrology and ecosystem function	<ul style="list-style-type: none"> <li>Avoid and/or minimize work in designated wetlands. Restore any affected wetland areas and/or provide compensatory mitigation as required by the agencies.</li> </ul>
Water Resources—North and South Shore AOIs	<b>Construction, Operation/Maintenance</b> Contamination of subsurface, ground water, and/or aquifers from possible spills of worksite pollutants	<ul style="list-style-type: none"> <li>Due to sensitive aquifer designation, develop and implement a plan for spill prevention, control, and countermeasures to avoid, minimize, and react to potential inadvertent spills.</li> <li>Restricting fueling locations, multiple forms of containment for contaminants and drilling waste storage, implementing erosion control on disturbed land, monitoring rain events, and having a spill prevention control and countermeasure (SPCC) plan in place.</li> </ul>

## Potential Environmental Impacts—Specific to the Tunnel Alternative

Potentially Affected Environment	Potential Construction, Operation/Maintenance Impact	Potential Mitigation Measures
<b>Hazardous Materials/Waste—North and South Shore AOIs</b>	<b>Construction</b> Tunnel boring would generate cuttings and sediments that are screened from the bentonite slurry	<ul style="list-style-type: none"> <li>Filter and recycle bentonite slurry to remove solids to enable the slurry to be reused and minimize waste. Waste materials would also be segregated to the extent practicable into properly managed streams.</li> <li>There will also be inflow water that will be pumped back to the north portal throughout tunneling operation. That water will go to a settling pond, from which it will be treated prior to discharge (subject to permitting, etc.).</li> </ul>
<b>Noise—North and South Shore AOIs</b>	<b>Construction</b> Noise from generator installed at worksite for the heating of cutting fluids during winter months	<ul style="list-style-type: none"> <li>If a generator is installed, it should include a noise dampening enclosure.</li> </ul>
<b>Water Resources—North and South Shore AOIs</b>	<b>Construction</b> Interruption of service in nearby wells due to cone of depression effects* if a large amount of groundwater is released during the drilling process	<ul style="list-style-type: none"> <li>Monitor groundwater seepage during drilling, monitor nearby wells for potential affects to aquifers if applicable.</li> <li>Hydraulic model to be developed in detailed design, from which permissible inflow rate to tunnel can be set; probe grouting to be specified in conditions of high flow.</li> </ul>
<b>Visual Impacts—North and South Shore AOIs</b>	<b>Operations</b> Visual impacts from new facilities—potential that cap structure of the tunnel portals would contrast with existing conditions	<ul style="list-style-type: none"> <li>If possible, locate the tunnel portals near the existing North Straits Station and Mackinac Station as an expansion of existing facilities.</li> <li>To the extent practicable given on-going need for maintenance and security, the cap structure could be screened with native vegetation that is appropriate to the context of the existing vicinity. The structure cap should appear to blend into its surrounding environment.</li> </ul>

\* If water is pumped out of an area faster than it replenishes with natural groundwater, the level of water in the water table tends to drop, leaving the well dry until it fills again with fresh groundwater.

## Potential Environmental Impacts— Specific to the Open Cut with Secondary Containment Alternative

Potentially Affected Environment	Potential Construction, Operation/Maintenance Impact	Potential Mitigation Measures
<b>Aquatic Organisms and Their Habitat— Open Water AOI</b>	<b>Construction</b> Disturbance of the lake bottom during open cutting that creates: <ul style="list-style-type: none"> <li>Underwater noise</li> <li>Habitat disturbance of fish and benthic organisms (those that live in and on bottom of lake floor) from open water light</li> <li>Impact to diel vertical migrations—the synchronized movement of zooplankton and fish up and down in the water column over a daily cycle</li> </ul>	<ul style="list-style-type: none"> <li>Use methods other than pile driving or other excessive noise producing methods, or use noise reducing methods.</li> <li>Survey benthic habitat below drilling rigs and in open cut area to determine if unique habitat or species are in the area.</li> <li>Conduct surveys of the shallows for sensitive fish habitat. Post-construction plant aquatic vegetation and restore to pre-construction condition (backfill all sediments).</li> <li>Use minimal construction lighting, direct lighting to the ground away from shore, or use lights that do not penetrate water as deep as white light near the shoreline.</li> <li>Operate open water drilling during daylight hours, if possible.</li> </ul>
	Disturbance of lake bottom that creates turbidity; dredging would cause significant turbidity	<ul style="list-style-type: none"> <li>Use silt curtains, construct during low current, open cut methods, or other best management practices (BMPs) to reduce turbidity.</li> <li>Time dredging during low current periods, use dredging methods and BMPs. If possible, avoid dredging during Lake Trout and Lake Whitefish spawning (October – December).</li> </ul>
	Installation of cover over the trench and pipe would increase turbidity	<ul style="list-style-type: none"> <li>Use washed rock, and methods such as a tremie line that place rather than drop the rock into place to reduce sediment disturbance and the velocity.</li> </ul>
	Interruption of littoral sediment transport because of the installation of sheet piling*	<ul style="list-style-type: none"> <li>Model littoral sediment transport to predict the effect of sheet piling.</li> <li>Physically moving sediment deposited on the up-drift side of the sheet piling could help reduce the effects of habitat alteration. Minimizing the amount of time the sheet piling will be in place will also help reduce effects.</li> <li>If possible, avoid sheet piling and shoreline open cutting during Lake Trout and Lake Whitefish spawning (October – December).</li> </ul>
	Alteration of shallow water habitat	<ul style="list-style-type: none"> <li>Restore habitat with aquatic vegetation plantings, relocate mussels, replace excavated substrate. Avoid disturbance during times of spawning and rearing of fish of special interest.</li> </ul>
<b>Open Water AOI— Straits of Mackinac Shipping Channel</b>	<b>Construction</b> Construction may disrupt/divert marine traffic within the channel	<ul style="list-style-type: none"> <li>Prepare and implement a public information plan in consultation with the USCG; Coordinate with USCG on managing potential impacts to marine traffic.</li> </ul>
<b>Near Shore Habitat— North and South Shore AOIs</b>	<b>Construction</b> Disturbance of the shore habitat for construction of the trench entrance and installation of sheet piling	<ul style="list-style-type: none"> <li>Choose location with minimal impact to aquatic plants and animals, restore the shoreline to pre-construction condition after construction is complete.</li> </ul>
<b>Aquatic Environment— Open Water AOI, including the Great Lakes</b>	<b>Construction</b> Aquatic invasive species introduction	<ul style="list-style-type: none"> <li>Implement an aquatic invasive species plan.</li> </ul>

\* Littoral transport is the term used for the transport of non-cohesive sediments, i.e. mainly sand, due to the action of breaking waves and the longshore current.



Potentially Effected Environment	Potential Construction, Operation/Maintenance Impact	Potential Mitigation Measures
<b>Hazardous Materials/Waste— Open Water AOI</b>	<b>Construction</b> If disturbed lake bottom sediment contains contaminants they would be released into the water during dredging spreading pre-existing impacts	<ul style="list-style-type: none"> <li>• Sampling and chemical analysis of sediments could be considered to address potential existing contaminants.</li> </ul>
<b>Noise Impacts— North and South Shore AOIs</b>	<b>Construction</b> Noise created during sheet piling or winching process	<ul style="list-style-type: none"> <li>• When possible, perform these construction activities during the daytime hours.</li> </ul>
<b>Boulevard Drive— North Shore AOI</b>	<b>Construction</b> A section of Boulevard Drive south of Densmore Avenue and east of the single-family residences may need to be closed for an extended period during construction	<ul style="list-style-type: none"> <li>• Prepare and implement a detour and signing plan for the affected section of Boulevard Drive.</li> </ul>
<b>Visual Impact— Open Water AOI</b>	<b>Construction</b> Lighting associated with nighttime construction on the marine platforms or tugboats/barges could spill outside of the project site, substantially affecting visitors to the Headlands International Dark Sky Park	<ul style="list-style-type: none"> <li>• Coordination with Headlands International Dark Sky Park regarding planned operation of marine platform lighting that would substantially reduce potential for effects on night skies from proposed construction activity. Specifically, limits could be placed on open water construction lighting during times of day and year when attendance is high at the Dark Sky Park, or when special events are planned.</li> </ul>
<b>Straits of Mackinac Shipping Channel— Open Water AOI</b>	<b>Operations Maintenance</b> Inspection of the pipelines may disrupt/divert marine traffic within the channel	<ul style="list-style-type: none"> <li>• Coordinate with USCG on managing potential impacts to marine traffic. Utilize unmanned underwater inspection techniques to reduce the need for boats and associated interference with marine traffic.</li> </ul>

# Reliability Assessment of the Two Feasible Alternatives

The wide-ranging agreement regarding Line 5 that the State of Michigan and Enbridge signed on November 27, 2017, acknowledges the importance of the Straits of Mackinac to the people of Michigan and our mutual commitment to ensuring that everything possible is being done to reduce the risk of operating Line 5.

To better understand future risks of a new Line 5 across the Straits, Enbridge engaged C-FER, which works with the global energy industry to advance safety, environmental performance and efficiency, to complete a reliability assessment to estimate the probability of a product release into the Straits for the two feasible alternatives—tunnel; and open cut with pipe-in-pipe (PIP) secondary containment and covered with approximately six to eight feet (measured from top of pipe) of engineered protective cover made of gravel and cobble.

C-FER's probability estimate is based on the scope described in the tunnel and open cut sections above.

For consistency, some of the data used in this reliability assessment was taken from a report prepared by a company called Dynamic Risk for the State of Michigan titled *Alternatives Analysis for the Straits Pipelines, 2017* (the Dynamic Risk Report).

Before estimating the probability of a product release into the Straits, C-FER first had to determine what event could cause the pipe to fail. These events are referred to as “threats”.

C-FER divided the threats into two categories:

- **Independent threats:** These are threats that would affect the product pipe and the secondary containment system—tunnel or outer pipe—independently. For example, corrosion or a fatigue crack could impact the product pipe without having any impact on the tunnel or the outer pipe in the PIP system.
- **Joint threats:** These are threats that would affect both the product pipe and the secondary containment system. For the tunnel alternative, the tunnel itself would be considered secondary containment. For the PIP system, the outer pipe provides the secondary containment. For example, an anchor drag is a joint threat because an anchor-hooking event could damage both the product pipe and outer pipe.

The threats that were considered for the tunnel and open cut with PIP alternatives are as follows:

### Tunnel Independent and Joint Threats

An event that results in product being released into the Straits would require the product to find a path from the tunnel into the lake bottom. Factors that could create such a path would be determined by the permeability of: the tunnel lining; the grouting that surrounds the pipeline; and the bedrock. Based on the Dynamic Risk Report, it was determined that the probability of failure due to geotechnical threats that can fail both the pipeline and the tunnel is not a credible threat.

**No credible joint threats:** Considering the proposed design of the tunnel (as described in the Tunnel section above), it is reasonable to conclude that the probability of product escaping the tunnel and entering the water in the Straits is so low that it is considered virtually zero—referred to as negligible.

#### Operating error (incorrect operation)

After thoroughly reviewing the Dynamic Risk Report, C-FER is comfortable accepting the threat assessment and review carried out in that report that determined incorrect operation is the only credible threat for the tunnel alternative.

▶ **Product Pipe—treated as a credible threat:** For a release into the Straits, not only would the product pipe need to fail, but the tunnel would also need to fail. The probability of this occurring is virtually zero as described above.

### Open Cut with Secondary Containment: Independent Threats

#### Operating error (incorrect operation)

This is a term used by the Pipeline and Hazardous Materials Safety Administration (PHMSA) to describe human factors that can become critical elements in certain types of pipeline and equipment failures. Common examples of incorrect operations are: accidental over-pressurization; inadequate or improper corrosion control measures; and improperly maintaining, repairing or calibrating piping, fittings or equipment.

▶ **Product Pipe—treated as a credible threat.**

#### Manufacturing defects in welds

▶ **Manufacturing defects outer pipe—treated as a credible threat:** Since the outer pipe cannot be hydrostatically tested after being installed, potential manufacturing defects on the pipe or welds would not be identified. If there were existing manufacturing defects on the outer pipe and the inner product pipe failed, the space between the two pipes could fill with product and then a leak in the outer pipe could occur.

**Also considered but deemed not credible was:**

▶ **Manufacturing defects product pipe—not a credible threat:** The product pipe would be hydrostatically tested, which would reveal pipe or weld defects. To further evaluate this threat, a fatigue-life model was run using a conservative industry accepted approach, referred to as the S-N Curve. The results determined that the fatigue life of the product pipeline is estimated at greater than 1,000 years.

#### Delayed mechanical (construction) damage

Mechanical damage is damage to the pipe from contact with an object that occurs either during pipeline construction, operation or maintenance resulting in a dent and/or gouge to the pipe.

▶ **Outer Pipe—treated as a credible threat:** The outer pipe could be damaged during construction, and any dents, gouges, coating loss or other defects could be susceptible to corrosion and/or environmental cracking over time. The ability to monitor these defects is limited because inline inspections cannot be used on the outer pipe. This is treated as a credible threat.

**Also considered but deemed not credible was:**

▶ **Product Pipe—not a credible threat:** Because the product pipe will be contained within the outer pipe, mechanical damage during installation or operation construction damage is not considered to be a credible threat.

## Open Cut with Secondary Containment: Joint Threats

### Accidental or inadvertent anchor deployment

To estimate the probability of a product release into the Straits caused by an anchor deployment, C-FER first had to determine the following:

1. The probability that an accidentally deployed anchor large enough to exceed the critical load limit of the pipeline, hooks the pipeline and drags it. The critical load limit is the greatest force the PIP system can tolerate without being damaged and rupturing.
2. The probability of hooking with the engineered protective cover over the PIP system. The engineered protective cover is expressly designed to protect the pipeline from an anchor strike. This was estimated using information from the risk assessment of an offshore gas pipeline design in Hong Kong (Environment Resources Management 2010) that suggests engineered cover has a 99 percent probability of preventing an anchor hook. This means the engineered cover will reduce the probability of a pipeline failure from an anchor hook by a factor of 100.

► **Credible threat to both the product and outer pipe:** The PIP system would fail if hooked by an anchor from a vessel of sufficient size/weight, creating an impact that exceeds the critical load limit for either the product pipe or outer pipe—whichever occurs first.

### Also considered but deemed not credible was:

#### Independent Threat: Corrosion

► **Product and outer pipe—not a credible threat:** Based on the proposed design, the space between the product pipe and outer pipe (the annulus) would be pressurized to 60 psi with an inert gas (such as nitrogen). The pressurized nitrogen blanket would reduce the potential for atmospheric corrosion. So, it is reasonable to conclude that corrosion of the outer surface product pipe and the inner surface outer pipe is not credible.

#### Independent Threat: Stress corrosion cracking (SCC) for the product pipe

► **Product pipe—not a credible threat:** The outside of the product pipe will be coated with an FBE coating that is not susceptible to SCC. Also, exposure of the product pipe to environmental corrosive elements and to wet-dry cycles is eliminated because the product pipe would be inside the outer pipe.

## Probability of a Product Release into the Straits

The table below describes the probability estimates for the two feasible alternatives—tunnel; and open cut with secondary containment.

As a baseline, C-FER has also included the estimate for the existing dual-lines.

The probabilities of pipe failure for all credible threats except for inadvertent anchor deployment, were obtained from the Dynamic Risk Report. All calculations and more details on how C-FER conducted its analysis is included in *Appendix 7*.

*Probability of a Release into the Straits*

	Tunnel	Open Cut with Secondary Containment		Existing dual Line 5 pipelines
	Probability per year	Probability per year		Probability per year
Independent threats		Product pipe	Outer pipe	
Incorrect operations	Negligible—considered virtually zero	$5.04 \times 10^{-5}$ *	**	$1.01 \times 10^{-4}$ *
Material defects	**	**	$5.51 \times 10^{-6}$	**
Construction damage	**	**	$8.47 \times 10^{-7}$	**
Vortex-induced vibrations	**			$3.22 \times 10^{-6}$
Overstress unsupported spans	**			$1.05 \times 10^{-8}$
<b>Probability of product being released into the Straits caused by an independent threat</b>	<b>Negligible—considered virtually zero</b>	<b><math>3.20 \times 10^{-10}</math></b>		<b>Not applicable as there is no secondary containment</b>
<b>Joint threats—anchor drag</b>	<b>Negligible—considered virtually zero</b>	<b><math>2.43 \times 10^{-7}</math></b>		<b><math>7.35 \times 10^{-4}</math></b>
<b>Total probability of product being released into the Straits— independent and joint threats:</b>				
	<b>Negligible—considered virtually zero</b>	<b><math>2.43 \times 10^{-7}</math></b>		<b><math>8.39 \times 10^{-4}</math></b>

\* The difference in value reflects the fact that the existing dual Line 5 pipelines are two separate product pipes and the PIP is a single-product line.

\*\* Not a credible threat.

## Key Findings

- For the tunnel alternative, there is no credible scenario that would result in a release of product into the Straits.
- For the PIP system, the probability of a release into the Straits is reduced to a very low value by the secondary containment feature of the outer pipe.
- For the existing dual pipelines, the primary contributors to a release of product into the Straits would be an inadvertent anchor deployment and incorrect operations.



# Enbridge's Conclusions

Enbridge used a robust process for assessing the feasibility of each alternative identified in the Agreement with the State. A team of subject matter experts—Lead Engineering Consultants, Independent Consultants, Constructibility Reviewers, Environmental Consultants and the Reliability Consultant renowned for their expertise and recognized leaders in their respective fields—evaluated and assessed each alternative to determine the engineering considerations, costs, potential environmental impacts, and permits and approvals required.

- The feasibility of each alternative went through multiple levels of expert review.
- There was consensus among the respective experts about the technical feasibility.

Out of that process, Enbridge has concluded the following:

### Summary Comparison of Critical Factors

	Tunnel	Open Cut with Secondary Containment	Horizontal Directional Drilling
Enbridge's opinion	Technically Feasible	Technically Feasible	Not Feasible
Lead Engineering Consultant's opinion	Technically Feasible	Technically Feasible	Not Feasible
Independent Consultant's opinion	Technically Feasible	Technically Feasible	Not Feasible
Constructibility Reviewer's opinion	Constructible	Constructible	Not Constructible given present-day technology
Environmental Impacts—additional details provided in table below	Least impactful construction process—would have no impact to shores lines or lakebed; marine work only required during the geotechnical program	Construction impacts to the shore lines and lakebed; marine work for two consecutive summer seasons, plus one summer season for geotechnical investigation/surveys	–
Estimated cost	\$350 – 500 million	\$250 – 300 million	–
Project timeline—engineering and design, permitting and construction.	5 to 6 years	4 to 5 years	–

**Other Critical Considerations for the Technically Feasible Alternatives**

	<b>Tunnel</b>	<b>Open cut with secondary containment</b>
<b>Risk of product release into the Straits</b>	<b>Negligible—considered virtually zero</b> For the tunnel alternative, there is no credible scenario that would result in a release of product into the Straits.	<b>2.43 x 10<sup>-7</sup></b> The secondary containment feature of the PIP system combined with the engineered protective cover reduces the probability of a release into the Straits to a very low value.
<b>Potential environmental impacts</b>	<b>Construction:</b> No impact to shorelines and lakebed; onshore work space 10 to 15 acres on north shore and two to eight acres on the south shore. <b>Operations:</b> Disturbed onshore areas would be reclaimed after construction; new operational footprint of approximately one acre on each shore.	<b>Construction:</b> Impact to shorelines likely to be considered minimal; impact to lakebed may not fit the regulators definition of minimal effects—likely would require an Individual Permit. Onshore workspaces six to eight acres in size on the north shore and one to two acres on the south shore would be required. <b>Operations:</b> Disturbed onshore areas would be reclaimed after construction; no new significant above-ground permanent facilities anticipated.
<b>Securing permits and approvals</b>  <b>Both projects will require approximately the same 15 permits/approvals from state and federal agencies and local authorities. There likely will be differences in the ease with which each alternative moves through the permitting processes.</b>	Least impactful construction process to the environment and stakeholders, which may make the permitting process less complex and contested.	<ul style="list-style-type: none"> <li>• The scope of the open cut would likely be considered by regulators to have the potential for impacts that may not fit the definition of minimal individual and cumulative adverse environmental effects. This means an Individual Permit likely would be required and that could prolong the permitting process.</li> <li>• There is a risk that increased stakeholder engagement and opposition could prolong the permitting process beyond the 21 months allowed in the schedule or could make securing permits unattainable.</li> </ul>

Enbridge will continue to work with the State in the spirit of openness and transparency to determine the optimal path forward for Line 5—one that respects both the importance of the Great Lakes to the people of Michigan and recognizes the vital energy that is being delivered by Line 5 to those same Michigan residents.

---

# Appendices



# Appendix 1: Tunnel Plan and Profile Drawings

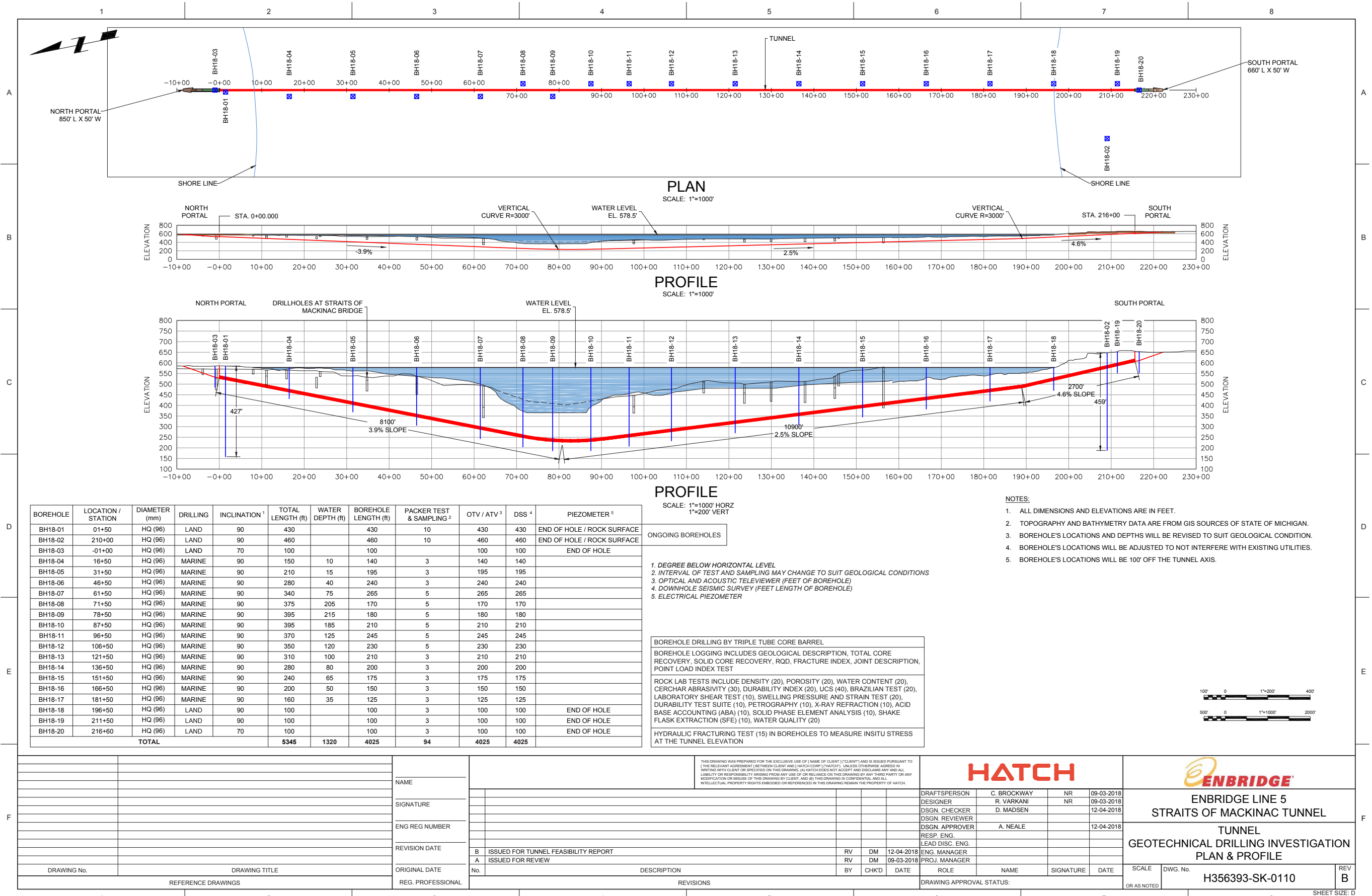



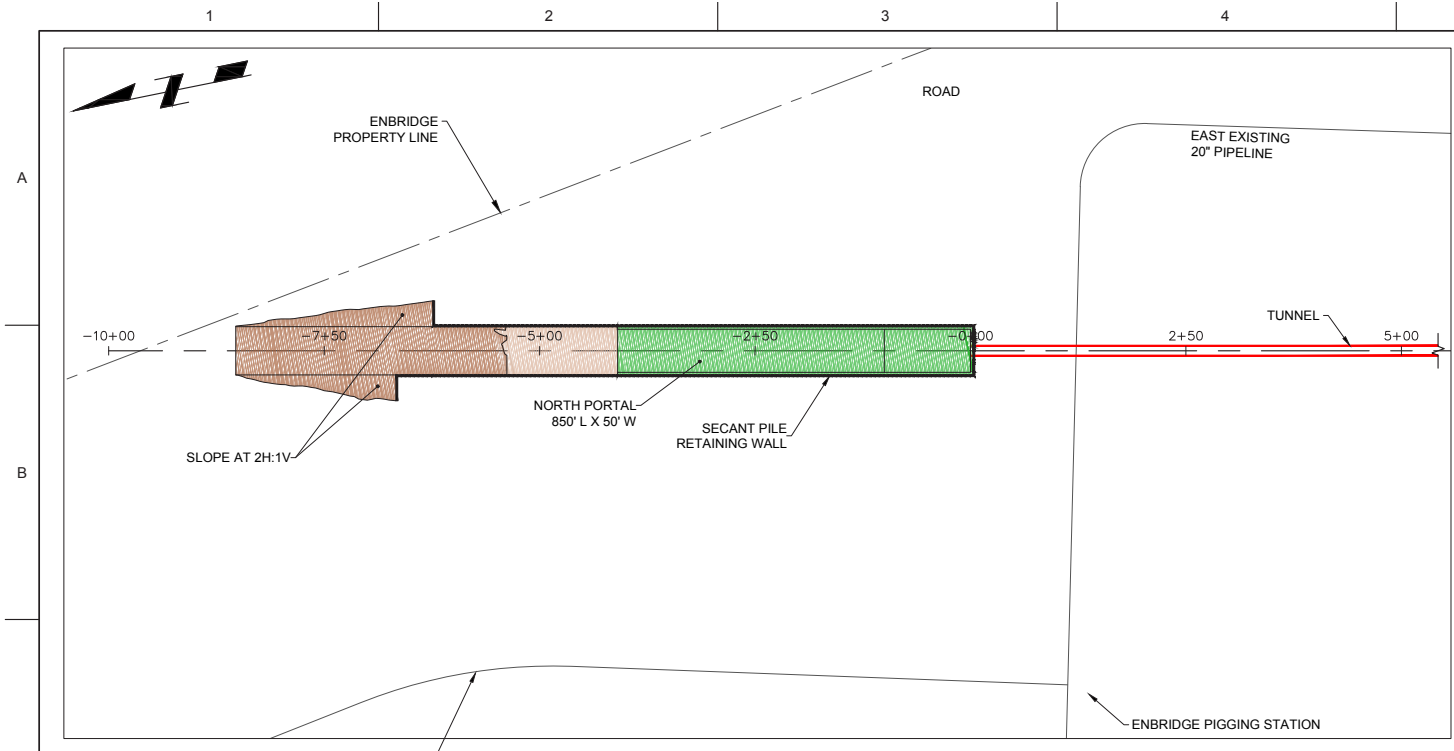

**NORTH PORTAL PLAN**  
SCALE: 1"=100'

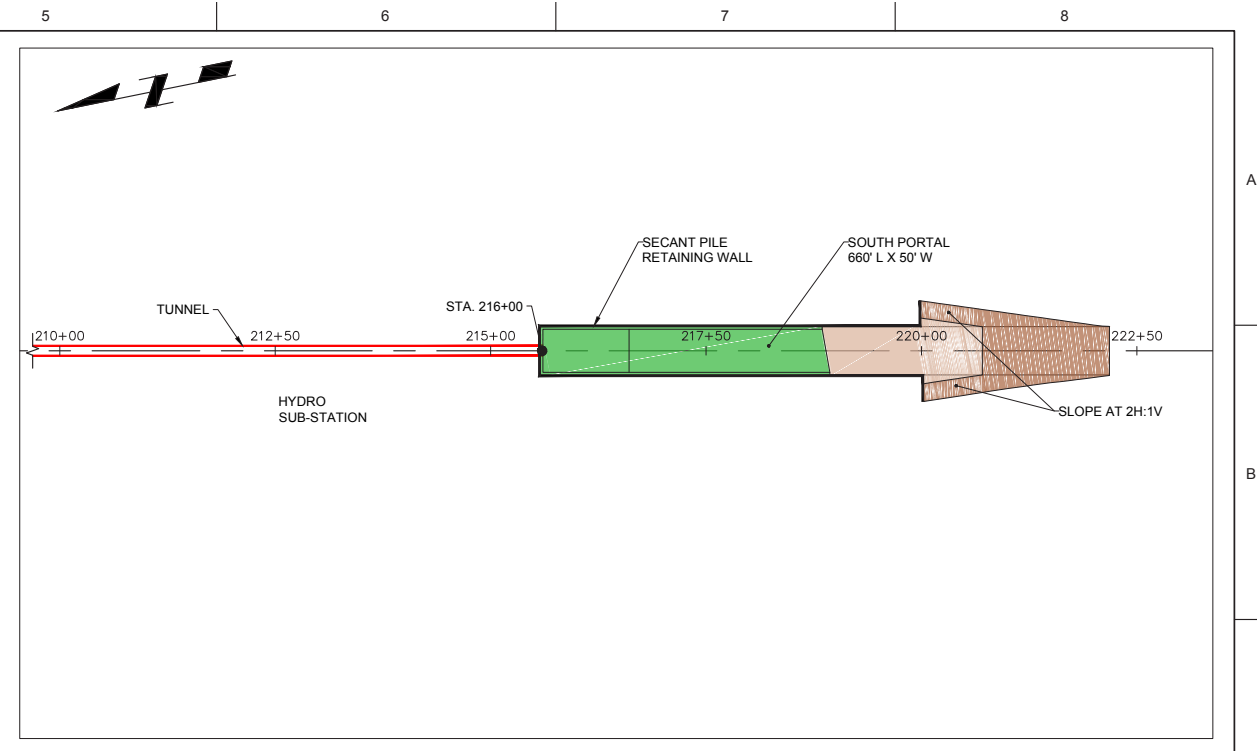

**SOUTH PORTAL PLAN**  
SCALE: 1"=100'

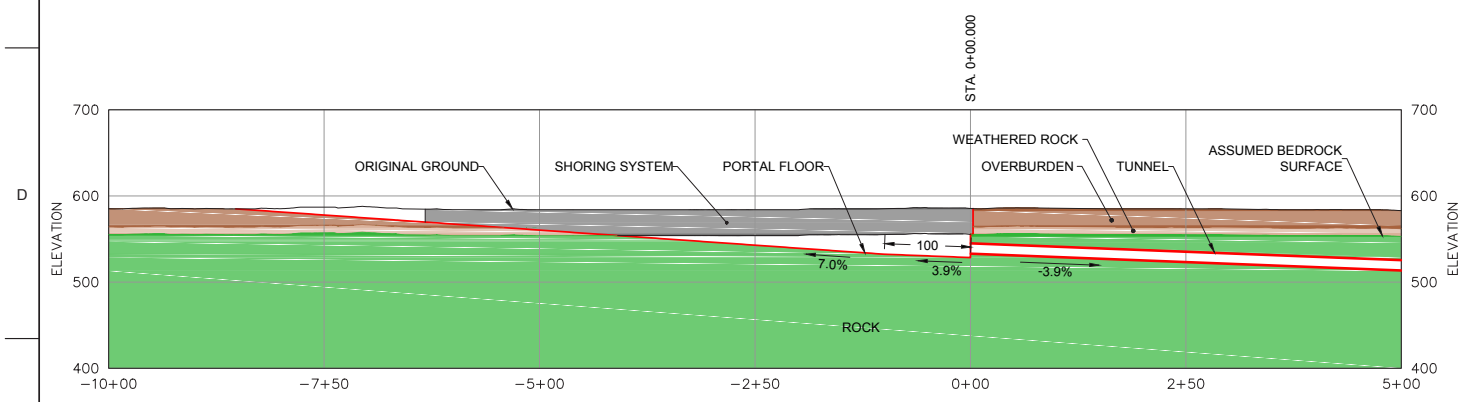

**NORTH PORTAL PROFILE**  
SCALE: 1"=100'

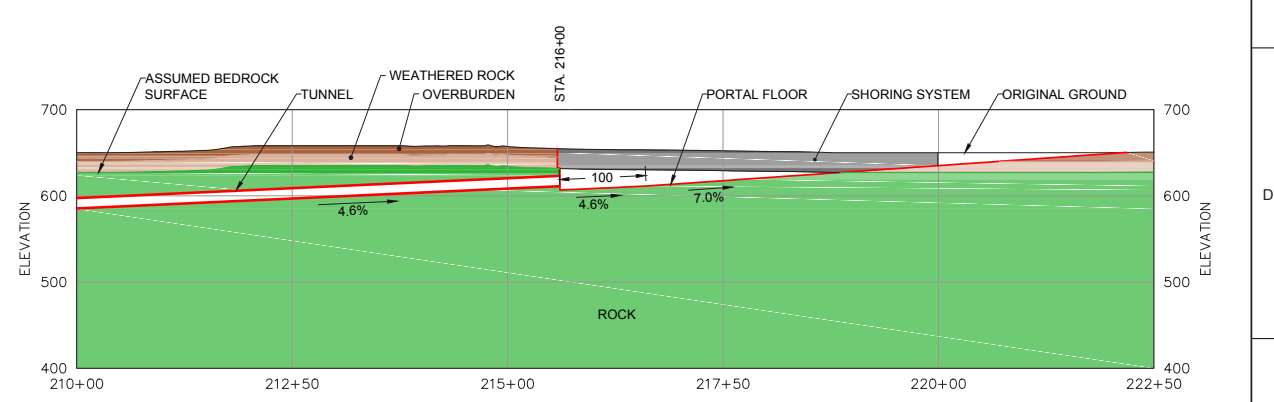

**SOUTH PORTAL PROFILE**  
SCALE: 1"=100'

- NOTES:**
1. ALL DIMENSIONS AND ELEVATIONS ARE IN FEET.
  2. TOPOGRAPHY AND BATHYMETRY DATA ARE FROM GIS SOURCES OF STATE OF MICHIGAN.
  3. TBM WILL BE LAUNCHED FROM NORTH PORTAL.



								<p>THIS DRAWING WAS PREPARED FOR THE EXCLUSIVE USE OF [NAME OF CLIENT] ("CLIENT") AND IS ISSUED PURSUANT TO THE RELEVANT AGREEMENT BETWEEN CLIENT AND HATCH CORP ("HATCH"). UNLESS OTHERWISE ADVISED BY WRITING WITH CLIENT OR SPECIFIED ON THIS DRAWING, HATCH DOES NOT ACCEPT AND DISCLAIMS ANY AND ALL LIABILITY OR RESPONSIBILITY ARISING FROM ANY USE OF OR RELIANCE ON THIS DRAWING BY ANY THIRD PARTY OR ANY MODIFICATION OR MISUSE OF THIS DRAWING BY CLIENT, AND (B) THIS DRAWING IS CONFIDENTIAL AND ALL INTELLECTUAL PROPERTY RIGHTS EMBODIED OR REFERENCED IN THIS DRAWING REMAIN THE PROPERTY OF HATCH.</p>		<p><b>HATCH</b></p>		<p><b>ENBRIDGE</b></p>	
		NAME				DRAFTSPERSON		C. BROCKWAY		NR		28-02-2018	
		SIGNATURE				DESIGNER		R. VARKANI		NR		28-02-2018	
		ENG REG NUMBER				DSGN. CHECKER		D. MADSEN				28-02-2018	
		REVISION DATE				DSGN. REVIEWER		A. NEALE				28-02-2018	
		ORIGINAL DATE		No.		RESP. ENG.							
		REG. PROFESSIONAL				LEAD DISC. ENG.							
DRAWING No.		DRAWING TITLE		DESCRIPTION		BY		CHK'D		DATE		ROLE	
REFERENCE DRAWINGS				REVISIONS		No.		DATE		NAME		SIGNATURE	
						B		DM		12-04-2018		ENG. MANAGER	
						A		DM		15-03-2018		PROJ. MANAGER	
												SCALE	
												OR AS NOTED	
												DWG. No.	
												H356393-SK-0107	
												REV	
												B	
												SHEET SIZE: D	

## Appendix 2:

### Accessible Tunnel—Advantages and Disadvantages

Advantages of an accessible tunnel	Disadvantages of an accessible tunnel
<ul style="list-style-type: none"><li>• Direct confirmation of pipeline condition and integrity below Lake Michigan is possible.</li><li>• Does not incur capital cost and truck-traffic impacts to backfill four-mile tunnel length.</li><li>• Tunnel space provides ability to add second pipeline or upgrade pipe for system expansion. There is potential for third-party services within the tunnel.</li><li>• Tunnel and pipeline inspection and maintenance is possible.</li><li>• Pipe flexibility is not compromised by possible ground movements.</li></ul>	<p>Maintenance costs for the following facilities, subject to services provided in tunnel:</p> <ul style="list-style-type: none"><li>• Walkways</li><li>• Safety and emergency procedures</li><li>• Permanent access track</li><li>• Ventilation</li><li>• Lighting</li><li>• Drainage system</li><li>• Emergency system</li><li>• Communication system</li></ul> <p>However, none of these would affect the feasibility of having an open, accessible tunnel.</p>

## Appendix 3:

### Backfilled Tunnel—Advantages and Disadvantages

Advantages of a backfilled tunnel	Disadvantages of a backfilled tunnel
<ul style="list-style-type: none"><li>• Proven methodology in pipeline tunnels</li><li>• Operation and maintenance (labor, training, equipment) is same as any other pipeline</li><li>• No permanent pipe supports required</li><li>• Increased security, with buried pipeline preventing access to tunnel</li><li>• Reduced land use at portals as no need for structures, electricity, communications, vehicle access, etc.</li><li>• Reduced operating costs as no regular maintenance visits for pipe inspections, monitoring equipment, etc.</li></ul>	<ul style="list-style-type: none"><li>• No access to the pipe after completion, no ability to inspect or repair sections of pipe if needed</li><li>• Must pre-build to future-proof pipeline capacity. This could include spare pipes or other third-party utilities</li><li>• Design life of pipe is controlled through measures such as corrosion protection, pipe coating, cathodic protection and inline inspection</li><li>• Pipe must be designed and maintained such that replacement or repairs not needed over design life</li><li>• More expensive capital cost to backfill four-mile-long tunnel length with cementitious material</li></ul>

# Appendix 4: High-Level Schedules for Each Feasible Alternative

## Tunnel Schedule = 5–6 years

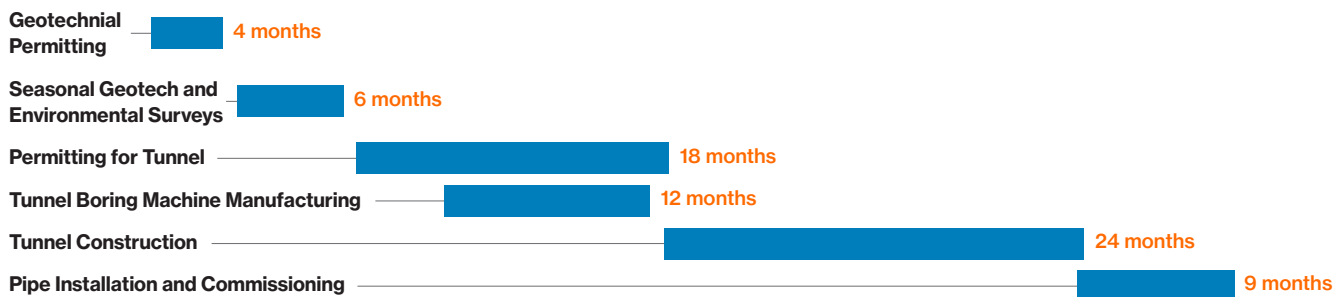
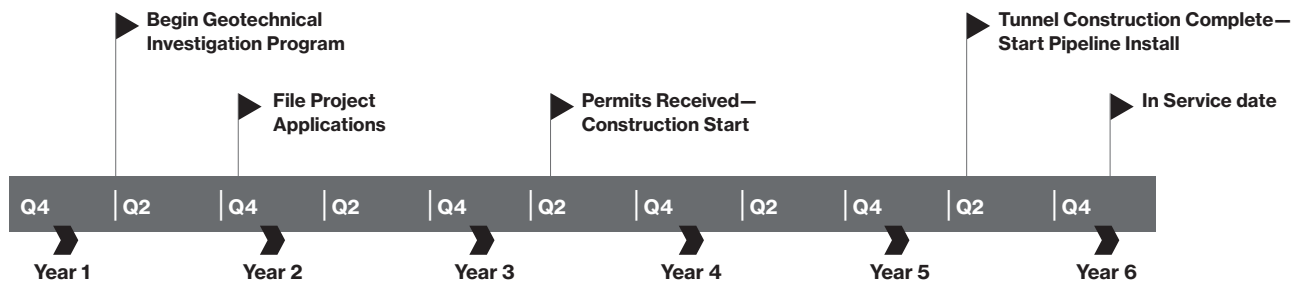

## Open Cut with Secondary Containment Schedule = 4–5 years

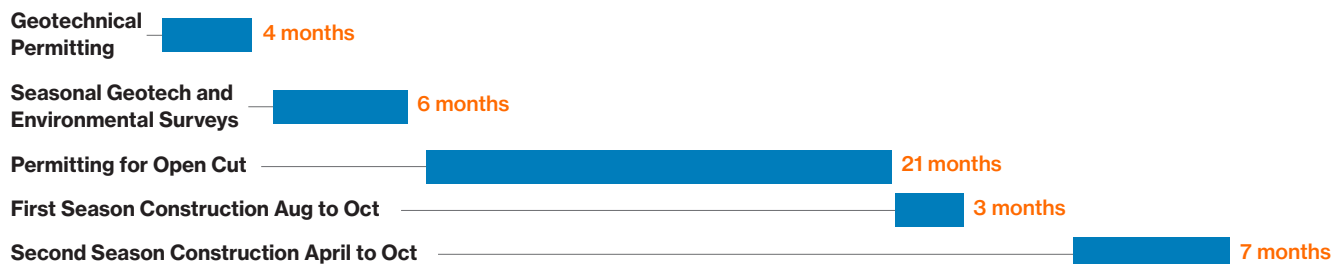
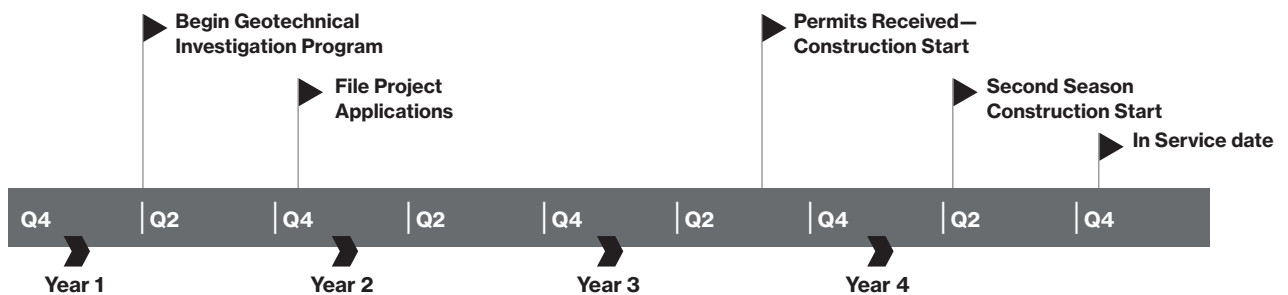

### Considerations:

- The schedule is sensitive to seasonal restrictions—icing of the Straits, fish spawning, shoreline nesting birds, etc.—that limits the construction window to about Apr-Oct. This means if there are any delays in the schedule, construction could be pushed to a third construction season for a project timeline of about five years.

## Appendix 5:

# Permits and Approvals Required for the Tunnel and Open Cut with Secondary Containment

Permitting durations would largely be driven by the time necessary to complete any environmental reviews and consultations that would be required under federal and state law. The timing for completing these tasks would be under the control of the permitting agencies.

The following tables describe the most likely permits and approvals that would be required.

### Survey and geotechnical boring permits and approvals

These approvals would be needed in order to complete the engineering design.

Agency, Authority	Jurisdiction	Permit, Authorization, Survey or Consultation	Tunnel	Open Cut
U.S. Army Corps of Engineers	Federal	Nationwide Permit— Clean Water Act Section 404 for geotechnical bore hole drilling program	✓	✓
Michigan Department of Environmental Quality	State	State General Permit—Part 303 Wetlands protection for geotechnical bore hole drilling program-if wetlands impacted also Part 325 Submerged Lands Permit	✓	✓
Michigan Department of Environmental Quality	State	Individual Permit—Part 325—if Great Lakes bottomland is disturbed	✓	✓
U.S. Coast Guard	Federal	Individual Authorization—Section 10 Regulated Navigation Area or Safety Zone and Notification for Marine Traffic	✓	✓

## Construction and operation permits and approvals

Agency, Authority	Jurisdiction	Permit, Authorization, Survey or Consultation	Tunnel	Open Cut
<b>Environmental Permits</b>				
U.S. Army Corps of Engineers (USACE)	Federal	Nationwide Permit 12 or Regional General Permit K submerged utility line crossings—Section 404 Clean Water Act	✔	✔
Michigan Department of Environmental Quality (MDEQ)	State	State Individual Permit—Natural Resources and Environmental Protection Act (NREPA), Part 303 Wetlands Protection-if wetland impacted	If regulated wetlands impacted	If regulated wetlands impacted
USACE	Federal	Individual Permit—Section 10 of the Rivers and Harbors Act, and Section 404 of the Clean Water Act	✔	✔
MDEQ	State	Permits required for impacts to Great Lakes Bottomlands—NREPA Part 325	If bottomlands impacted	✔
MDEQ	State	State Individual Permit or General/Minor Permit—NREPA Part 301 Inland Lakes and Streams	If stream is impacted*	If stream is impacted*
MDEQ	State	State Individual Permit—NREPA Part 323 Shorelands Protection and Management	If environmental area impacted	If environmental area impacted
MDEQ	State	NREPA Part 21 (General Real Estate Powers)—Easement for public utilities	May require new bottomland easement	May require new bottomland easement
U.S. Fish and Wildlife Service (USFWS)	Federal	Coordination and Report—Section 7 Endangered Species	✔	✔
Michigan Department of Natural Resources (MDNR)	State	Coordination and Report—Part 365 Endangered species Protection	✔	✔
USACE in coordination with State Historic Preservation Office (SHPO) and Tribal Historic Preservation Offices (THPO)	Federal	Consultation and Report—Section 106 National Historic Preservation Act	✔	✔
Mackinac, Emmet counties	Local	Soil erosion permit—Part 91, Part 31 NOC	Dependent upon location/size of earth disturbance	✔
MDEQ	State	Hydrostatic Test Permit—Individual Permit or Certificate of Coverage	✔	✔
U.S. Coast Guard	Federal	Individual Authorization—Section 10 Regulated Navigation Area or Safety Zone and Notification for Marine Traffic	Required for geotechnical investigation	✔
<b>Regulatory—State</b>				
Michigan Public Service Commission	State	Certificate of Public Convenience and Necessity	✔	✔



Authority	Tunnel	Open Cut
<b>Local Consultation and Authorization**</b>		
Moran Township	<ul style="list-style-type: none"> <li>• Building Permit</li> <li>• Certificate of Zoning Compliance</li> <li>• Site Plan Review</li> <li>• Variance Application</li> <li>• Special Use Permit</li> <li>• Noise and lighting</li> </ul>	<ul style="list-style-type: none"> <li>• Building Permit</li> <li>• Certificate of Zoning Compliance</li> <li>• Site Plan Review</li> <li>• Variance Application</li> <li>• Special Use Permit</li> </ul>
City of St. Ignace	<ul style="list-style-type: none"> <li>• Building Permit</li> <li>• Plumbing, Electrical, or Drainage Permit may be required after building inspector's review of building permit application.</li> <li>• Special Land Use Permit</li> <li>• Sign Permit</li> <li>• Fence Permit</li> </ul>	<ul style="list-style-type: none"> <li>• Building Permit</li> <li>• Electrical Permit may be required after building inspector's review of building permit application.</li> <li>• Special Land Use Permit</li> <li>• Sign Permit</li> <li>• Fence Permit</li> </ul>
Emmet County	<ul style="list-style-type: none"> <li>• Building Permit</li> <li>• Zoning Permit</li> <li>• Electrical Permit</li> <li>• Mechanical Permit</li> <li>• Septic/Well Permit</li> <li>• Plumbing Permit</li> <li>• Fence Permit</li> <li>• Site Plan Review Application</li> <li>• Special Use Permit</li> <li>• Noise and lighting</li> </ul>	<ul style="list-style-type: none"> <li>• Building Permit</li> <li>• Zoning Permit</li> <li>• Electrical Permit</li> <li>• Fence Permit</li> <li>• Site Plan Review Application</li> <li>• Special Use Permit</li> </ul>
Mackinaw City	<ul style="list-style-type: none"> <li>• Excavation/Fill Permit</li> <li>• Site Plan Review and Approval</li> <li>• Zoning Permit</li> <li>• Special Use Permit</li> <li>• Building Permit</li> <li>• Certificate of Occupancy</li> <li>• Sign Permit</li> </ul>	<ul style="list-style-type: none"> <li>• Excavation/Fill Permit</li> <li>• Site Plan Review and Approval</li> <li>• Zoning Permit</li> <li>• Special Use Permit</li> <li>• Building Permit</li> <li>• Sign Permit</li> </ul>

\* A regulated intermittent stream may be present in the north shore AOI

\*\* Some of these permits may be covered by a broader agreement with the local municipalities/counties

We will also comply with all the requirements of the federal Pipeline and Hazardous Materials Safety Administration.

# Appendix 6: Environmental Areas of Interest

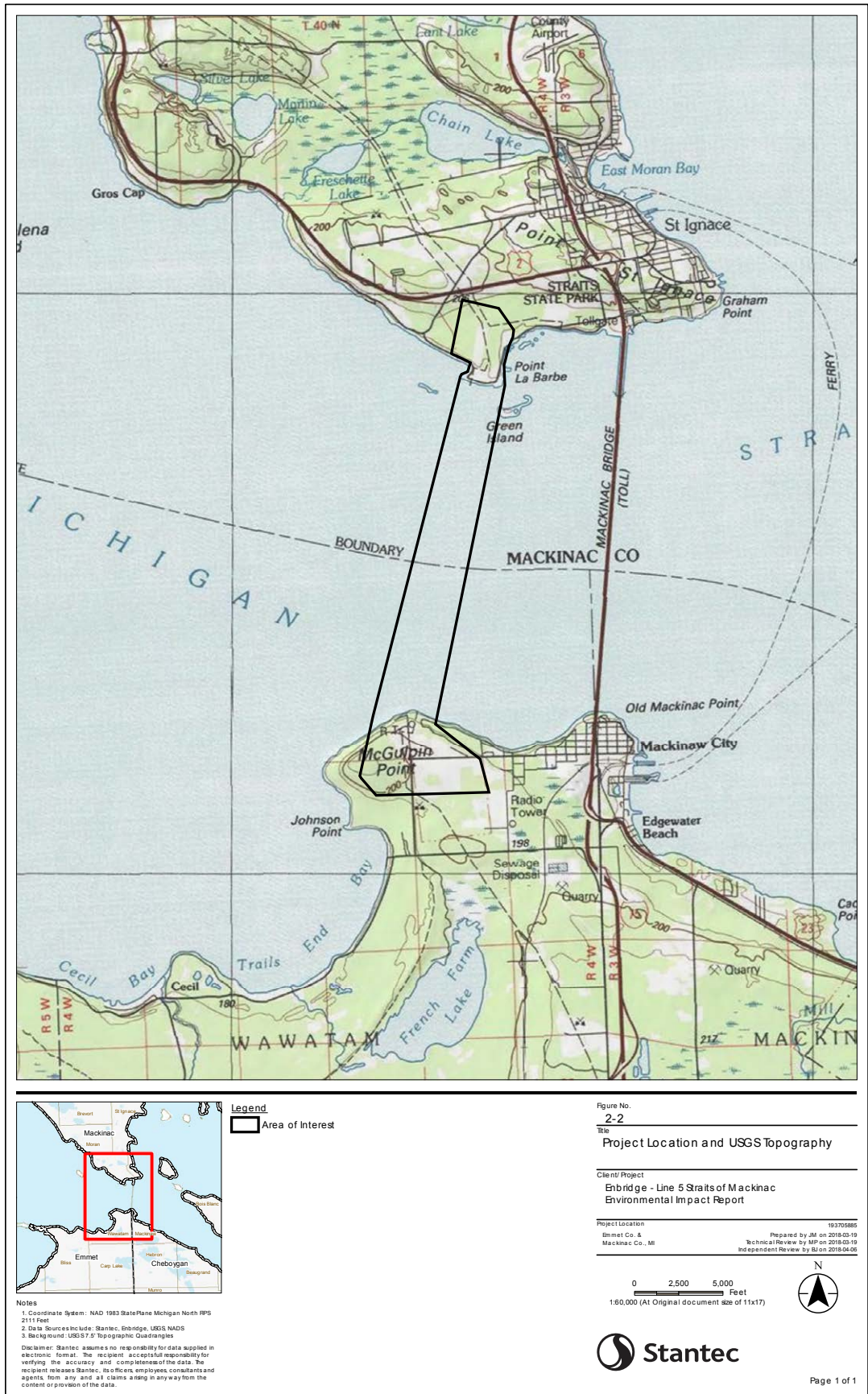

# Appendix 7: Reliability Assessment



Tel 780.450.3300

Fax 780.450.3700

[www.cfertech.com](http://www.cfertech.com)

200 Karl Clark Road  
Edmonton, Alberta  
Canada T6N 1H2

June 8, 2018

C-FER File: M269

Enbridge Energy Company, Inc.  
1409 Hammond Avenue  
Superior, WI 54880

Attention: Project Development – Major Projects, Enbridge

Dear Sir or Madam:

**Re: Letter Report - Reliability Assessment of Mackinac Straits Crossing Alternatives for Line 5**

## 1. INTRODUCTION

C-FER Technologies (1999) Inc. (“C-FER”) was engaged by Enbridge Energy Company, Inc. (“Enbridge”) to estimate the probability of product release into water from the Line 5 crossing of the Mackinac Straits (the “Straits”). The probability was estimated for the following three scenarios:

- 1) **Scenario 1:** The existing dual-line crossing, consisting of two 20 in. pipelines, installed on the lake bed in 1953. A description of the physical attributes and condition data of the pipelines was obtained from the report titled *Alternative Analysis for the Straits Pipelines* (referred to herein as “Alternative Analysis Report”), which was prepared by Dynamic Risk for the State of Michigan (2017).
- 2) **Scenario 2:** A new single-line pipe-in-pipe crossing, consisting of a 30 in. product pipe and a 36 in. outer pipe, installed on the lake bed with engineered gravel and rock backfill. The pipeline design and operational parameters used in the probability estimation for this scenario were based on the design basis report provided by Enbridge (INTECSEA 2018a, 2018b).
- 3) **Scenario 3:** A new 30 in. pipe installed in a concrete-lined tunnel beneath the Straits. The probability analysis for this scenario was based on the design information in the tunnel feasibility report provided by Enbridge (Hatch 2018).

The scope of the probabilistic analysis was limited to releases from the pipeline segment crossing the Straits; buried pipeline segments either upstream or downstream of the crossing were not considered. Furthermore, the magnitude of the release and the resulting potential damage were not considered.

*Notice: All reasonable efforts were made to ensure that the work conforms to accepted scientific, engineering and environmental practices, but C-FER makes no other representation and gives no other warranty. Any use or interpretation of the information contained herein is at Enbridge's own risk.*

**Advancing Engineering Frontiers**  
O&G Operations Pipelines Structures

## 2. METHODOLOGY

The probability of product release into water,  $P(Product)$ , can be characterized as the joint probability of loss of containment from both the product pipe and the secondary containment (where applicable). Considering that multiple threats can result in loss of containment, the threats can be divided into two categories: those that affect the product pipe and secondary containment jointly (e.g., anchor drag) and those that affect the product pipe and secondary containment independently (e.g., corrosion or fatigue crack growth). Based on this separation of threats, the probability of product release into water can be formulated as

$$P(Product) = P_i(Product) + \sum_{j=1}^n P_j(LOC_p \cap LOC_s) \quad [1]$$

where

- $P(Product)$  = probability of product release into water;
- $P_i(Product)$  = probability of product release into water only due to independent failure mechanisms of the product pipe and secondary containment; and
- $P_j(LOC_p \cap LOC_s)$  = joint probability of loss of containment from product pipe and secondary containment due to  $j^{\text{th}}$  threat out of  $n$  credible joint threats.

For the independent threats only,

$$P_i(Product) = P(LOC_p) \times P(LOC_s) \quad [2]$$

where

- $P(LOC_p)$  = probability of loss of containment from the product pipe only; and
- $P(LOC_s)$  = probability of loss of containment from the secondary containment only.

The approach used to calculate  $P(LOC_p)$  consists of three steps: 1) threat assessment to identify credible threats; 2) probability assessment to quantify the probability of loss of containment associated with each credible threat; and 3) estimation of  $P(LOC_p)$  due to all credible threats as

$$P(LOC_p) = \sum_{i=1}^n P_i(LOC_p) \quad [3]$$

where

- $P_i(LOC_p)$  = probability of loss of containment due to  $i^{\text{th}}$  threat out of  $n$  credible independent threats.

A similar approach was adopted to assess  $P(LOC_s)$ . The probability estimates were based on the historical incident rates from the industry-wide databases where possible, even if these provide conservative estimates for new pipelines, and the values from the Alternative Analysis Report were



Enbridge Energy Company, Inc.

June 8, 2018

leveraged where possible to limit the amount of new information for consideration by the State of Michigan. For Scenario 1, as there is no secondary containment, Equation [1] reduces to

$$P(\text{Product}) = P(\text{LOCp}) \quad [4]$$

### 3. SCENARIO 1: EXISTING DUAL-LINE CROSSING

The design details and properties of the existing dual-line crossing are listed in Table 1 (Dynamic Risk 2017).

Parameter	Value
Diameter	20 in.
Wall Thickness	0.812 in.
Grade	API 5L Grade A
Year of Installation	1953
Coating Type	Coal tar enamel
Maximum Operating Pressure (MOP)	600 psi
Seam Type	Seamless

**Table 1 Pipeline Parameters in Scenario 1**

The Alternative Analysis Report included a threat assessment that was conducted for the 12 threats listed in the API Recommended Practice on Managing System Integrity for Hazardous Liquid Pipelines (API 2013). A review of the threat assessment results led to the identification of the following credible threats and failure mechanisms:

- *Ship anchor drag due to inadvertent anchor deployment:* The failure mechanism associated with this threat is anchor hooking resulting from an accidentally deployed anchor leading to excessive pipe denting or tensile rupture of the pipe due to deformation in response to the lateral load imposed by the hooked anchor. The probability estimation for this threat accounts for vessel crossing frequency, anchor load limits as affected by vessel and anchor size, and the critical dent amplitude and tensile strain limit for the pipe, as affected by pipe size and lake bed restraint conditions.
- *Incorrect operations:* This threat covers errors related to operating processes and procedures, and gaps in training. As sufficient information does not exist to support consideration of these factors individually, the probability was estimated using industry-wide incident statistics collected between 2002 to 2016 by the U.S. Department of Transportation Pipeline and Hazardous Materials Safety Administration (PHMSA).
- *Fatigue due to vortex-induced vibrations:* The failure mechanism due to this threat is fatigue of the pipe at a free-span in response to current-induced vortex shedding. Probability estimates were



obtained using Monte Carlo analysis wherein the fatigue life was estimated by modelling both span lengths and current velocity as random variables.

- *Overstress in unsupported spans affected by gravity and drag forces:* The failure mechanism is defined as the onset of plastic deformation (i.e. a Von Mises combined effective pipe body stress in excess of the yield stress) in response to internal pressure and axial and bending forces resulting from gravity loading and current-induced drag forces.

The probabilities of pipe failure due to all credible threats, except for inadvertent anchor deployment, were obtained from the Alternative Analysis Report. For anchor drag, an underlying assumption in the Alternative Analysis Report for the estimation of the probability is that an inadvertently dropped anchor would be discovered within one hour. C-FER has considered an alternative basis for the detection of a deployed anchor by assuming the detection during the routine vessel activities to be a random process with a 90% probability of detecting the deployment within a standard vessel watch-keeping period of eight hours, and estimated the average time to discover a deployed anchor as 3.5 hours. The change to the underlying assumptions and subsequent revised computations have resulted in an update to the probability of pipe failure due to anchor drag estimated in the Alternative Analysis Report.

Table 2 shows the probabilities of failure as estimated by C-FER for inadvertent anchor deployment, and as taken from the Alternative Analysis Report for all other threats. Among the credible threats, vortex-induced vibration is a fatigue-related time-dependent failure mechanism and, therefore, the estimated probability varies as a function of time. The Alternative Analysis Report provided estimates of the combined failure probability for both segments for five-year intervals between 2018 and 2053. In this report, the probability of failure due to vortex-induced vibrations was conservatively taken as the average annual value over the five-year interval between 2048 and 2053. The individual threat annual failure probability estimates and the corresponding values of  $P(LOC_p)$  and  $P(Product)$ , as calculated from Equations [3] and [4], are shown in Table 2. The probabilities in Table 2 are for the entire crossing, consisting of two 3.87 mi. branches.

Threat and Failure Mechanism	Probability (per yr)
Inadvertent anchor deployment	$7.35 \times 10^{-4}$
Incorrect operations	$1.01 \times 10^{-4}$
Vortex-induced vibrations	$3.22 \times 10^{-6}$
Overstress in unsupported spans	$1.05 \times 10^{-8}$
$P(LOC_p)$ – total of the above	$8.39 \times 10^{-4}$
$P(Product)$	$8.39 \times 10^{-4}$

**Table 2 Annual Probabilities of Release for Scenario 1**

**4. SCENARIO 2: PROPOSED SINGLE-LINE PIPE-IN-PIPE CROSSING**

**4.1 Threat Assessment**

Table 3 gives a summary of the design parameters for the proposed pipe-in-pipe crossing as obtained from the design basis report and preliminary design details provided by Enbridge (INTECSEA 2018a, 2018b).

Parameter		Value
Diameter	Product Pipe	30 in.
	Outer Pipe	36 in.
Wall Thickness	Product Pipe	0.688 in.
	Outer Pipe	0.812 in.
Grade		API 5L X65
Coating Type	Product Pipe	Fusion bonded epoxy (FBE)
	Outer Pipe	Three-layer polypropylene (3LPP)
Maximum Operating Pressure (MOP)		1440 psig
Seam Type		Double submerged arc-welded (DSAW)

**Table 3 Pipe-in-pipe Design Parameters**

In the Alternative Analysis Report, a threat assessment was conducted for a new 30 in. single-walled pipe design in a trenched crossing, and the credible threats for that option were identified as inadvertent anchor deployment and incorrect operations. Although the proposed design involves installing the pipe on the lake bed with engineered backfill, threat analysis in the Alternative Analysis Report was considered to be applicable because the lateral restraint provided by the engineered backfill mitigates the threats in a similar manner to a trenched installation. However, since the pipe-in-pipe design has a higher MOP than the original single pipe design, the threat assessment was revisited to ensure that any additional threats related to the increased pressure and the presence of an outer pipe are included. The additional threats considered and the associated conclusions are described below:

- *Corrosion for product and outer pipes:* The Alternative Analysis Report suggested that atmospheric corrosion of the outer surface of the product pipe and the internal surface of the outer pipe can occur at the points of pipe contact with spacers due to moisture in the annulus. This deterioration mechanism has been observed in onshore cased pipes, where significant atmospheric corrosion is frequently observed around the points of pipe contact with the casing or other supports. For the proposed design, the annulus will be pressurized to 60 psi with an inert gas (such as nitrogen) and will be monitored for pressure changes. This will prevent the incursion of oxygenated air and reduce the potential for atmospheric corrosion of the surfaces in the annulus

(C-CORE et al. 2000). Therefore, it is reasonable to conclude that corrosion of the outer surface of the product pipe and the inner surface of the outer containment pipe is not a credible threat.

- *Stress corrosion cracking (SCC) for product pipe:* The increase in MOP over the value considered in the 30 in. single pipe scenario results in changing the hoop stress in the product pipe from 17% of the specified minimum yield strength (SMYS) to 48% SMYS. However, the outside of the product pipe will be coated with an FBE coating, which is known not to be susceptible to SCC (Michael Baker Jr. 2005). Furthermore, as the product pipe is contained within an outer pipe, exposure to an external corrosive environment and to wet-dry cycles is eliminated. Therefore, SCC is not considered to be a credible threat.
- *Manufacturing defects in product and outer pipes:* Fatigue of seam weld defects is a potential threat for the product pipe because the increase in MOP influences the stress range resulting from pressure cycling. To evaluate this threat, a deterministic check of the fatigue life of the product pipe was performed based on the conservative S-N approach described in DNV-RP-C203 (DNV 2010). For this check, pressure cycle frequency data from the Alternative Analysis Report was used, with the pressure cycle ranges in that report being increased in proportion to the increase in MOP. This deterministic check resulted in a fatigue life greater than 1000 years, which demonstrates that pressure-induced seam weld fatigue is not a credible threat for the product pipe. Since the outer pipe will not be hydrostatically tested, the potential for the presence of manufacturing defects in the pipe or seam weld cannot be excluded. Such defects can lead to outer pipe failure in the unlikely event of the annulus being filled with product<sup>1</sup> due to a release from the product pipe. Under that scenario, the internal pressure in the annulus can reach the MOP of the product pipe, which corresponds to a hoop stress of 49% SMYS in the outer pipe. Considering that the reduction in hoop stress due to external pressure at the water depths considered is relatively small, the outer pipe failure due to manufacturing defects was treated as a credible threat.
- *Delayed failure due to mechanical damage for product pipe:* As the product pipe is contained within an outer pipe, external mechanical damage to the product pipe's surface is unlikely. Therefore, mechanical damage occurring during installation or operation is not considered to be a credible threat. This removes the potential for fatigue failure of external damage features, such as dents and gouges.
- *Construction damage for outer pipe:* The exterior of the outer pipe is subject to mechanical damage during construction and installation that can result in dents, gouges, coating loss or other subcritical defects. These resident imperfections may grow by such mechanisms as corrosion and environmental cracking. The ability to monitor these defects in the outer pipe is limited as inline inspection is not possible. Therefore, construction damage is treated as a credible threat.

In summary, the credible threats for the proposed pipe-in-pipe design are:

---

<sup>1</sup>The annulus is likely to be filled with enough product to induce internal pressure on the outer pipe only in the event of leak or rupture of the product pipe, and if the leak or rupture remains undetected for a significant duration.

Enbridge Energy Company, Inc.

June 8, 2018

- Independent threats:
  - Product pipe:
    - Incorrect operations
  - Outer pipe:
    - Manufacturing defects
    - Construction damage
- Joint threats:
  - Inadvertent anchor deployment and dragging by the ships crossing the Straits

#### 4.2 Probability of Release Due to Independent Threats

For the outer pipe, the failure probabilities due to manufacturing defects and construction damage were estimated from offshore pipeline historical failure rates summarized in DNV-2009 1115 (DNV AS 2010). The historical failure rates were expressed on an annual basis per kilometer and were therefore multiplied by the crossing length (3.87 mi. valve to valve) to convert them to the annual probabilities for the entire crossing. It is noted that the historical failure rates include pipelines of various diameters and installation dates and are therefore considered to be upper bound estimates for a new pipeline.

For the product pipe, the failure probability due to incorrect operations was obtained from the Alternative Analysis Report. Since this scenario involves only a single-line (and, therefore, is one-half of the total length of the existing dual-line pipe), this probability equals one-half of the probability of failure due to incorrect operations for the existing dual-line scenario (see Table 2).

Table 4 shows the summary of the probability estimates and the probability of product release due to only independent threats computed using Equation [2].

Threat and Failure Mechanism	Probability (per yr)	
	Product Pipe	Outer Pipe
Incorrect operations	$5.04 \times 10^{-5}$	-
Material defects	-	$5.51 \times 10^{-6}$
Construction damage	-	$8.47 \times 10^{-7}$
Probability of LOC	$5.04 \times 10^{-5}$	$6.35 \times 10^{-6}$
Probability of product release due to independent threats	$3.20 \times 10^{-10}$	

**Table 4 Probability for Release for Independent Threats in Scenario 2**

#### 4.3 Probability of Release Due to Joint Threats

The approach provided in DNV-2009 1115 Appendix E (DNV AS 2010) was used to estimate the pipe-in-pipe system failure probability due to inadvertent anchor deployment. As the DNV approach is applicable only to single pipe, it was modified for the pipe-in-pipe system considered in this scenario. The modifications are based on the following assumptions:

- The product and containment pipes constituting the pipe-in-pipe system will experience the same lateral deformations as they are dragged together by the anchor.
- Failure of the system occurs when the critical load limit is reached for either the product pipe or outer pipe, whichever occurs first.
- Installation of pipe on the lake bed with engineered gravel backfill is equivalent to a trenched installation in hard soil in the DNV approach.

The critical loads and corresponding displacements were calculated separately for the product and outer pipes (see Table 5).

Pipe	Critical Load Limit (kips)	Lateral Displacement at Critical Load (in.)
Product pipe (30 in.)	540	55
Outer pipe (36 in.)	700	55

**Table 5 Critical Load Limits Due to Anchor Drag**

Since both the product and outer pipes reach the critical load limit at the same displacement, the total critical load limit is simply the sum of both critical load components, which is  $540+700 = 1240$  kips.

Ships with maximum anchor chain break loads that exceed 1240 kips have displacements of approximately 114,550 tons or greater (using linear interpolation between the values provided in Table E.5 of DNV-2009 1115 (DNV AS 2010)). Over a three year period between 2014 and 2016, there were 161 crossings of the Straits by ships that exceed 114,550 tons displacement (U.S. Coast Guard 2018), which corresponds to 54 crossings per year.

DNV-2009 1115 (DNV AS 2010) defines and calculates the relative frequency of a number scenarios, according to which an accidentally deployed anchor can hook a subsea pipeline. For each scenario, DNV AS (2010) provides a model to estimate the probability of pipe hooking per ship crossing, considering the probability of inadvertent anchor drop, as well as the relative frequency of the different pipe hooking scenarios. Application of this model to ships with a displacement greater than 114,550 tons results in a probability of  $1.92 \times 10^{-7}$  that an anchor will hook the pipeline for each ship crossing. Underlying this probability is the assumption that the dropped anchor will be discovered within 20 mi. of deployment. C-FER's update of this model for the Straits has resulted in increasing this probability



Enbridge Energy Company, Inc.

June 8, 2018

to  $4.52 \times 10^{-7}$  per crossing. Multiplying this value by 54 crossings per year results in a failure probability of  $2.43 \times 10^{-5}$  per year for the pipe-in-pipe crossing.

The above results apply if an accidentally deployed anchor of sufficient size hooks the pipeline and drags it laterally. However, the pipe-in-pipe design considered by Enbridge uses engineered gravel and rock backfill designed to resist anchor penetration and act as a protective cover. The probability of hooking in the presence of an engineered backfill is difficult to assess without a detailed analysis based on the backfill dimensions and material, as well as anchor shape and size. As an alternative, the effectiveness of the engineered backfill was estimated using information from a quantitative risk assessment of an offshore pipeline design (Environmental Resources Management 2010), which suggests that engineered backfill has a 99% probability of preventing a hooking event that would have otherwise occurred. This means that an engineered backfill will reduce the probability of failure due to anchor hooking by a factor of 100. Based on this, the annual probability of release due to anchor drag is reduced by two orders of magnitude from  $2.43 \times 10^{-5}$  to  $2.43 \times 10^{-7}$ .

#### 4.4 Total Probability of Release

Table 6 summarizes the probability of loss of containment due to independent and joint threats, and the total probability of product release into water for Scenario 2.

Parameter	Probability (per yr)
Independent threats	$3.20 \times 10^{-10}$
Joint threat (anchor drag)	$2.43 \times 10^{-7}$
Total probability of product release into water: <i>P(Product)</i>	$2.43 \times 10^{-7}$

Table 6 Probability of Release for Scenario 2

#### 5. SCENARIO 3: PROPOSED SINGLE-LINE CROSSING IN TUNNEL

Pipe parameters for the proposed tunnel crossing are shown in Table 7, as provided by Enbridge. Based on the threat assessment, and review of the probability analysis in the Alternative Analysis Report, it was determined that the probability of failure due to geotechnical threats (such as seismic fault displacement) that can fail both the pipeline and tunnel is negligible. For independent threats, it was determined that incorrect operations is the only credible threat.

Parameter	Value
Diameter	30 in.
Wall Thickness	0.812 in.
Grade	API 5L Grade X65
Coating Type	Three-layer polyethylene (3LPE)
Maximum Operating Pressure (MOP)	1440 psig
Seam Type	Longitudinally double submerged arc-welded (L-DSAW)

**Table 7 Pipeline Parameters in Scenario 3**

The event of product reaching water requires a travel path for the product from the tunnel to the lake. Factors identified in the Alternative Analysis Report that influence the potential for product release to the lake through the tunnel walls include:

- permeability of the tunnel lining;
- options for grouting around the pipeline and permeability of the grout, if applicable; and
- permeability of the bed rock due to micro-fissures in the rock.

The Alternative Analysis Report concludes that the probability of product release from the tunnel is negligible. Assuming that the tunnel design and maintenance align with the design considerations noted in that report, it is reasonable to concur with this conclusion.

## 6. SUMMARY OF RESULTS AND CONCLUSION

The probability estimates for the three crossing scenarios considered in the project are summarized in Table 8. For Scenario 1 (the existing dual-line 20 in. pipes), inadvertent anchor deployment and incorrect operations are the primary contributors to the probability of product release into water. For the pipe-in-pipe design in Scenario 2, the release probability due to incorrect operations is reduced to an insignificant value by secondary containment, and anchor deployment is the dominant contributor. The release probability for the pipe-in-pipe design is approximately three orders of magnitude lower than the probability of release for the current dual-line crossing. For the tunnel crossing in Scenario 3, a credible situation that could result in a product release into the Straits cannot be identified and the probability of product release is judged to be negligible, or practically zero.

Scenario	<i>P(Product)</i> (per yr)
1. Existing Dual-line Crossing	$8.39 \times 10^{-4}$
2. Proposed Single-line Pipe-in-pipe Crossing	$2.43 \times 10^{-7}$
3. Proposed Single-line Crossing in Tunnel	negligible

**Table 8 Probability Assessment**

To provide context for the failure probabilities in Table 8, failure frequencies for hazardous liquid pipelines in different regions are shown in Table 9. To facilitate comparison, the failure frequencies are provided both on a per mile-year basis (as reported in the literature) and a per year basis for a single-line segment (to be more directly comparable to the crossing). The estimated probability of a release for the existing dual-line crossing is near the low end of the range of historical failure frequencies, whereas the two proposed options are associated with significantly lower release probability estimates. It is noted that the failure frequencies provided in Table 9 are associated with onshore liquid product pipelines and the reporting criteria (i.e. the consequence thresholds for release reporting) varies with the dataset. Therefore, while they provide reasonable context for interpreting the crossing failure probability estimates developed in this report, they should not be interpreted as directly comparable.

Region	Database	Reporting Period	Failure Frequency (per mi-yr)	Reference	Probability for a Single-line Segment (per yr)
U.S	PHMSA	2004-2015	$5.4 \times 10^{-4}$	Chen et al. (2016)	$2.1 \times 10^{-3}$
Europe	CONCAWE	1971-2010	$8.8 \times 10^{-4}$	Cunha (2012)	$3.4 \times 10^{-3}$
Canada	NEB	2000-2008	$1.6 \times 10^{-4}$	Cunha (2012)	$6.2 \times 10^{-4}$
Brazil	TRANSPETRO	1978-2010	$1.1 \times 10^{-3}$	Cunha (2012)	$4.3 \times 10^{-3}$

**Table 9 Historical Failure Rates of Liquids Pipelines**

Enbridge Energy Company, Inc.

June 8, 2018

Thank you for the opportunity to complete this project for Enbridge.

Yours sincerely,

Reviewed by,



A handwritten signature in blue ink, appearing to read "Mark Stephens".

Smitha Koduru, PhD, PEng  
Senior Research Engineer, Integrity & Operations  
Pipelines & Structures

Mark Stephens, MSc, PEng  
Senior Engineering Consultant  
Pipelines & Structures

APEGA Permit Number: P 04487

SDK/MAN/MJS/amm  
Attachments (1)

**REFERENCES**



References

- American Petroleum Institute (API). 2013. Managing System Integrity for Hazardous Liquid Pipelines. API Recommended Practice 1160, 2<sup>nd</sup> ed., September.
- C-CORE, Colt Engineering Corporation, Tri Ocean Engineering Ltd., & AGRA Earth & Environmental. 2000. An Engineering Assessment of Double Wall Versus Single Wall Designs for Offshore Pipelines in an Arctic Environment. Minerals Management Services, US Dept. of Interior, Publication No. 00-C4-Final, April.
- Chen J.J., Williams, D., Leewis, K., and Barnum, M. 2016. Long Term (1970 to 2015) Trending of the Nine Prescriptive Pipeline Threats. International Pipeline Conference, Calgary, Alberta, Canada, September 26-30, 2016, IPC2016-64503.
- Cunha, S.B. 2012. Comparison and Analysis of Pipeline Failure Statistics. International Pipeline Conference, Calgary, Alberta, Canada, September 24-28, 2012, IPC2012-90186.
- Det Norske Veritas AS (DNV AS). 2010. Energy Report – Recommended Failure Rates for Pipelines. Report No. 2009-1115, November 16.
- Det Norske Veritas (DNV). 2010. Fatigue Design of Offshore Steel Structures. Recommended Practice DNV-RP-C203, April.
- Dynamic Risk Assessment Systems, Inc. 2017. Alternatives Analysis for the Straits Pipelines. State of Michigan, Document No. SOM-2017-01-RPT-001, October 26.
- Environmental Resources Management. 2010. Black Point Gas Supply Project [current as of February 8, 2010]. Available from: [http://www.epd.gov.hk/eia/register/report/eiareport/eia\\_1782009/HTML/index.htm](http://www.epd.gov.hk/eia/register/report/eiareport/eia_1782009/HTML/index.htm)
- Hatch Corporation. 2018. Enbridge Line 5 Straits of Mackinac Tunnel Feasibility Report. Enbridge Major Projects, Document No. 356393-PM-230-S0-0002, March.
- INTECSEA, Inc. 2018a. Basis of Design for Enbridge Line 5 Straits of Mackinac Crossing Feasibility Study. Enbridge Pipelines Inc., Vendor Document No. 408005-400852-MX-BOD-001, February 12.
- INTECSEA, Inc. 2018b. Enbridge Line 5 Feasibility Study – Protective Barriers for Line 5 Across Straits of Mackinac. Document No. 408005-00898-MX-0001, May 3.
- Michael Baker Jr., Inc. 2005. Stress Corrosion Cracking Study. Department of Transportation, Document No. OPS TTO8, January.
- U.S. Coast Guard Navigation Center. 2014. NAIS Data Formats [current as of April 16, 2014]. Available from: <https://www.navcen.uscg.gov/?pageName=NAISDataFormats>

## Appendix 8: Consultants' Profiles

### Tunnel alternative

#### Lead Engineering Consultant: Hatch

Hatch is a global, multidisciplinary engineering consultancy with 8,000 employees in 65 offices on six continents. Tunneling is one of Hatch's core strength specialties, with roots beginning on Toronto's subway system in the 1950s. To date, Hatch has engineered more than 1,000 miles of constructed tunnels in soft soils and hard rock by TBM and drill and blast mining. With \$35 billion in projects under management, Hatch is providing feasibility, multi-disciplinary design and construction management of several major tunnel projects throughout North America and overseas. [hatch.com](http://hatch.com)

#### Independent Consultant: Aldea Services LLC

Aldea Services LLC has been at the forefront of the underground construction industry for over 20 years—planning, designing and constructing tunnel projects around the world, whether the functional purpose is water, wastewater, cable conduit, pipeline, transit or highway. Aldea Services have specialized expertise with bored and mined tunneling; the New Austrian Tunneling Method (NATM) for soft ground and hard rock; trenchless technology; shaft design; ground improvement; geotechnical instrumentation; foundation design; structural design; and contract document preparation. [aldeaservices.com](http://aldeaservices.com)

#### Constructibility Reviewer: Michels Corporation

Michels is an industry-leading utility contractor, offering pipeline construction, horizontal directional drilling, transmission, substation and distribution construction, cured-in-place pipe, direct pipe, fiber optic networks, rail plowing, heavy civil work, foundations, tunneling, paving, dewatering, custom crushing and road building. Michels has experience with a variety of tunneling techniques, including earth pressure balance TBMs, hard rock TBMs, conventional blast tunneling, sequential excavation methods and remote-controlled tunneling systems. [michels.us](http://michels.us)

### Open cut with secondary containment alternative

#### Lead Engineering Consultant: INTECSEA, Inc.

INTECSEA is a provider of engineering services that has designed subsea production systems, pipelines and floating systems for offshore field development and pipeline projects in the Gulf of Mexico, Arctic Ocean, North Sea, offshore Western Australia, Mediterranean Sea, Black Sea, offshore West Africa and South China Sea. Founded in 1984 and based in Houston, Texas, INTECSEA operates as a subsidiary of WorleyParsons Limited. [intecsea.com](http://intecsea.com)

#### Independent Consultant: Project Consulting Services, Inc. (PCS)

PCS is a pipeline and pipeline facility engineering and regulatory compliance firm, specializing in all phases from Pre-FEED analysis through start-up and operational support. PCS's scope of expertise spans from navigating Corps of Engineers permitting to engineering deepwater subsea tie-ins to 600-mile onshore pipeline reversals. The review provided by PCS for this report was from the Regulatory Compliance perspective. [projectconsulting.com](http://projectconsulting.com)

### **Constructibility Reviewers: Michael Baker International / Kokosing Industrial**

Michael Baker International is a leading provider of engineering and consulting services, including design, planning, architectural, environmental, construction and program management. The company provides its comprehensive range of services and solutions to support U.S. federal, state, and municipal governments, foreign allied governments, and a wide range of commercial clients. Since 1940, the company's multidisciplinary teams have successfully delivered services to oil and gas industry clients—from the design of the Trans-Alaska Pipeline System to the administration of the National Pipeline Mapping System. [mbakerintl.com](http://mbakerintl.com)

Kokosing Industrial is one of the largest contractors in the U.S. Midwest, serving the power, oil and gas, industrial, marine, heavy civil, water/wastewater and commercial sectors. Their Durocher Marine Division provides construction services for anything above or below water. Based in northern Michigan, Durocher Marine performed some of its first work near the Mackinac Bridge in the 1950s, and its equipment and crews can be found doing work throughout the Great Lakes, North America and the Caribbean. [kokosingindustrial.com](http://kokosingindustrial.com)

### **Horizontal directional drilling alternative**

#### **Lead Engineering Consultant: J. D. Hair & Associates, Inc.**

J. D. Hair & Associates, Inc. (JDH&A) is an industry leader in the design of horizontally directionally drilled pipeline crossings and has been a key member of design teams for some of the most significant and challenging pipeline projects ever completed. JDH&A is based in Tulsa, Oklahoma, but work on projects throughout the world. Since its founding in 1987, JDH&A has consulted on more than 1,000 HDD crossings in locations ranging from Alaska to Australia. Included among JDH&A's clients are Fortune 500 energy companies, major international design and construction firms, local utilities and HDD contractors. [jdhair.com](http://jdhair.com)

#### **Independent Consultant: GeoEngineers/ADIT Engineering**

GeoEngineers is an employee-owned earth science and technology firm that helps clients manage natural resources and the built environment. For more than 25 years, GeoEngineers has helped pipeline clients plan, build and maintain their infrastructure. GeoEngineers has completed more than one million feet of trenchless projects, and hundreds of HDD pipeline crossings throughout the United States, Central and South America, Asia, and Africa. [geoengineers.com](http://geoengineers.com)

ADIT Engineering provides front-end engineering and design, detailed design, and construction support for trenchless crossings, including HDD, microtunneling, Direct Pipe®, auger boring and pipe ramming. ADIT works with diverse industries on a wide range of projects, including oil and gas pipelines, municipal water and sewer infrastructure, electrical conduits, and remediation and dewatering wells. [adit-eng.com](http://adit-eng.com)

#### **Constructibility Reviewer: Michels Corporation**

Michels is an industry-leading utility contractor, offering pipeline construction, horizontal directional drilling, transmission, substation and distribution construction, cured-in-place pipe, direct pipe, fiber optic networks, rail plowing, heavy civil work, foundations, tunneling, paving, dewatering, custom crushing and road building. Michels has successfully completed HDD crossings in all 50 states, Canada, along the U.S.-Canada and U.S.-Mexico borders, and internationally. [michels.us](http://michels.us)

## Environmental

### **Lead Environmental Consultant: Stantec**

Stantec is an international engineering, environmental and technical services firm with five offices in Michigan. Their 2,700 North American environmental services staff and environmental sciences practice works with clients to assess environmental impacts, evaluate project requirements and prepare environmental assessments to meet regulatory standards.

**stantec.com**

### **Independent Environmental Impact Consultant: AECOM**

AECOM designs, builds, finances and operates infrastructure assets for governments, businesses and organizations in more than 150 countries. Their global environmental services practice is made up of more than 10,500 professionals specializing in 100+ topics, including impact assessment and permitting. **aecom.com**

## Reliability Assessment

### **Reliability Consultant: C-FER Technologies**

C-FER Technologies works primarily with the global energy industry—from upstream drilling and production operations, to midstream and downstream pipeline operations—to advance safety, environmental performance and efficiency. C-FER also provides global assistance in dealing with challenging applications, including deepwater operations and Arctic energy developments. C-FER's unique testing systems have also been used by such industries as aerospace, marine and construction. **cfertech.com**

## Appendix 9: Glossary

### Abbreviations and acronyms

3LPP	three-layer polypropylene	NSA	noise sensitive area
AOI	Areas of interest	OD	outside diameter
BMP	best management practice	PCTL	precast concrete tunnel lining
BSEE	Bureau of Safety and Environmental Enforcement	PHMSA	Pipeline and Hazardous Materials Safety Administration
CP	cathodic protection	PIP	pipe-in-pipe
CWA	Clean Water Act	psi	pounds per square inch
EPB TBM	Earth Pressure Balance tunnel boring machine	ROV	remotely operated vehicle
ESA	Endangered Species Act	SHPO	Michigan's State Historic Preservation Office
FBE	fusion bonded epoxy	SPCC	spill prevention control and countermeasures
FEED	front-end engineering design	SUP	Special Use Permit
ICCP	impressed current cathodic protection	SWPPP	Stormwater Pollution Prevention Plan
ID	inside diameter	TBM	tunnel boring machine
HDD	Horizontal directional drilling	TCP	traditional cultural property
JDH&A	J. D. Hair & Associates, Inc.	THPO	Tribal Historic Preservation Office
MDEQ	Michigan Department of Environmental Quality	UP	Upper Peninsula
MDNR	Michigan Department of Natural Resources	USACE	U.S. Army Corps of Engineers
NOC	Notice of Coverage	USCG	U.S. Coast Guard
NREPA	Natural Resources and Environmental Protection Act	USFWS	U.S. Fish and Wildlife Service



## Definitions

annulus	In a tunnel, the annulus is the space outside the concrete lining of the tunnel. In a pipe-in-pipe system, the annulus is the space between the inner (product) pipe and the outer pipe.
bar	A metric unit of pressure defined as approximately 100 kilopascals, which is approximately equal to the atmospheric pressure on Earth at sea level. Bar is used as a measure hydrostatic and atmospheric pressure. Thirty-three feet of water depth is approximately equal to one bar.
bentonite	A clay consisting mostly of montmorillonite, which swells significantly when combined with water, allowing a drill hole to counteract formation pressure and remain open. In tunneling, bentonite is also used as a medium to seal and support the tunnel face and to transport excavated material.
hydrostatic pressure test	Also called hydrostatic testing, it involves filling sections of pipe with water to a high pressure and maintaining the pressure for a prescribed period of time to confirm the integrity of the pipeline.
karst	Karst is a topography formed from the dissolution of soluble rocks such as limestone, dolomite, and gypsum. It is characterized by underground drainage systems with sinkholes and caves.
lacustrine	Soils formed on or from lacustrine deposits, i.e. material deposited in lake water and later exposed.
slurry	Any fluid mixture of a pulverized solid or rock with a liquid, typically water.
tie-in	The connection of a pipeline to a facility or to other pipeline systems, or the connecting together of different sections of a single pipeline.







200, 425 – 1st Street S. W.  
Calgary, Alberta, Canada T2P 3L8

Telephone: 403-231-3900  
Facsimile: 403-231-3920  
Toll free: 800-481-2804

[enbridge.com](http://enbridge.com)